



Catalog Price List 503.03  
Effective June , 2014





Catalog Price List 503.03  
Effective June, 2014

## Catalog Price List 503.03 Classroom and Technology Solutions

<u>Section</u>	<u>Category</u>	<u>Series</u>	<u>Page(s)</u>
Workcenters	Panel Base Desk	Evolutions	4
	Metal Base Desk	Evolutions	5-6
	Metal Base Computer Tables	6000 Series	7
		7000 Series	8
		8000 Series	9-13
		9000 Series	14
	Panel Base Computer Desk	2000 Series	15
		3000 Series	16-17
		4000 Series	18
	Study Carrels		19
	Lecturns		20
	Workcenter Accessories	Computer Accessories	21
		Workspace Accessories	22-25
		Connectors & Panels	26-27
Electrical		28	
Tables	Steel Base Classroom		26-30
	Wood Base Classroom		31
	Wood Base Science		32
	Steel Base Science		33-34
	Drafting Tables		35
	Multipurpose Art Table		36
Bookcases	Laminated Bookcases		37
	Mobile Bookcases		38

2014 Catalog Price List 503.03  
Storage Solutions

<u>Section</u>	<u>Category</u>	<u>Page(s)</u>
Music Storage Solutions	Instrument Storage	39-46
	Robe/Uniform Storage	47-48
	Folio Storage	49-50
	Cello & Bass Storage	50
Mobile Storage Solutions	Metal Frame Construction	51-52
	All Panel Construction	53-54
	Mobile Storage Accessories	55
Custom Storage Solutions	Base Cabinets	57-58
	Drawer Banks	58
	Tall Storage	59
	Wall Storage	60
	Accessories	61

### Model 561-D360 - 24 Unit Mobile Desk w/ Tablet Storage and Charging

Specially designed to function fully as a standard desk with the added benefit to store, charge and secure your Tablets and similar electronic devices.



### Model 912-6010 - Instructor's Lectern

Specially designed to function fully as a standard desk with the added benefit to store, charge and secure your Tablets and similar electronic devices.



Model Number	Dimensions (D" x W" x H)	Description	List Price
561-D360	30" X 60" X 29.5"	Mobile Tablet Desk	2250
912-6010	22" X 24" X 46"	Instructor Lectern	1320
550-1410		Optional Tablet Mount	295

<b>Options</b> (Please Specify When Ordering)	
Laminate Color:	(MA) Maple, (SH) Shaker Cherry (GC) Grand Cherry, (GN) Grey Nebula (EC) Extend Color Options - Nearly 200 additional colors, patterns & woodgrains.
Shipping:	<b>Ships (Assembled) - Freight code 125</b>

### 8500 Series - Steel Base Desk

Description	Model Number	Dimensions D" x W" x H"	Ship Wt	List Price
-------------	--------------	----------------------------	---------	------------



#### Tables/Desks - Fixed Height

562D236	24" X 36" X 30"	72	477
562D248	24" X 48" X 30"	92	515
562D260	24" X 60" X 30"	102	569
562D272	24" X 72" X 30"	128	603
562D336	30" X 36" X 30"	75	489
562D348	30" X 48" X 30"	95	533
562D360	30" X 60" X 30"	105	587
562D372	30" X 72" X 30"	130	627

- Standard modesty panel
- Heavy duty casters.
- 3mm PVC Edges
- High pressure laminate top with optional edge designs
- Powder coated, fully-welded steel frame base
- Optional metal keyboard tray and fixed/mobile pedestals.

#### Desk Builder

Any of these accessories may be added to suit your environment

- Keyboard Tray with Pencil Drawer
- Ergonomic Keyboard Tray
- Pencil Drawer
- CPU Holder
- Adjustable CPU Holder
- Backpack hanger

#### IN-LINE Mobile Pedestal



file/file box/box/file



box/file pencil/box/file

#### IN-LINE Hanging Pedestal



#### Options (Please Specify When Ordering)

Front Edge:	(R) Traditional Roll Edge - Standard, (C) Comfort Edge, (3) 3mm PVC Edge
Laminate Color:	(NO) Natural Oak, (LG) Light Gray, (GC) Grand Cherry, (MA) Maple, (GN) Grey Nebula (EC) Extend Color Options - Nearly 200 additional colors, patterns & woodgrains.
3mm PVC Edgeband Color:	(1) Black - Standard, (3) Light Gray, (M) Matching Woodgrain
Casters:	(C) Casters.... \$56
Shipping:	<b>Ships (KD) - Freight code 85</b>
Powder coat color:	(1) Silver - Standard, Black, Almond



## Model 529-A - Student Technology Desk

Specially designed to address the requirements of today's classroom technology. Provides for charging solutions, tablet safety, security issues and personal space organization



Options (Please contact for pricing)

- Metal Bookbag Hook
- Four Outlet Power Strip
- Laminate Book Shelf



Model Number	Dimensions (D" x W" x H)	Description	List Price
529-A230	24" X 30" X 24" - 36"	Single Student Desk	650
529-A260	24" X 60" X 24" - 36"	Double Student Desk	775
550-1410		Optional Tablet Mount	295
<b>Options</b> (Please Specify When Ordering)			
Laminate Color:	(MA) Maple, (SH) Shaker Cherry (GC) Grand Cherry, (GN) Grey Nebula (EC) Extend Color Options - Nearly 200 additional colors, patterns & woodgrains.		
Shipping:	<b>Ships (Assembled) - Freight code 125</b>		



This page is intentionally blank.

### 6000 - T Series - Steel Base Desk

Description	Model Number	Dimensions D" x W" x H"	Ship Wt	List Price
-------------	--------------	----------------------------	---------	------------



**Tables/Desks - Adjustable Height**

525A236	24" X 36" X 20"-36"	94	764
525A248	24" X 48" X 20"-36"	119	877
525A260	24" X 60" X 20"-36"	131	969
525A272	24" X 72" X 20"-36"	143	1024
525A336	30" X 36" X 20"-36"	100	798
525A348	30" X 48" X 20"-36"	127	895
525A360	30" X 60" X 20"-36"	140	993
525A372	30" X 72" X 20"-36"	153	1068

- Featuring Corilam's **Easy Access Top** wire management with nylon brush seal.
- Heavy duty floor levelers.
- High pressure laminate top with optional edge designs
- Adjustable height, powder coated, fully welded steel frame
- Modesty panel and a metal wire trough with grommet ends

**Desk Builder**

Any of these accessories may be added to suit your environment

- Keyboard Tray with Pencil Drawer
- Ergonomic Keyboard Tray
- CPU Holder
- Adjustable CPU Holder
- Book bag hook

**Options** (Please Specify When Ordering)

Front Edge:	(R) Traditional Roll Edge - Standard, (C) Comfort Edge, (3) 3mm PVC Edge
Laminate Color:	(NO) Natural Oak, (MO) Medium Oak, (WN) Walnut, (LG) Light Gray, (GC) Grand Cherry, (MA) Maple, (GN) Grey Nebula, (BG) Beige Granite, (ES) Ebony Sand  (EC) Extend Color Options - Nearly 200 additional colors, patterns & woodgrains.
Modesty Panel:	(1) Black - Standard, (3) Light Gray, (M) Matching
3mm PVC Edgeband Color:	(1) Black - Standard, (3) Light Gray, (M) Matching Woodgrain
Casters:	(C) Casters.... \$90
Shipping:	<b>Ships (A) Assembled— Freight code 125</b>
Powder coat color:	(1) Black—Standard, Almond, Light Gray

7000 Series - Steel Base Desk

Description	Model Number	Dimensions D" x W" x H"	Ship Wt	List Price
 <ul style="list-style-type: none"> <li>Featuring Corilam's <b>Easy Access Top</b> wire management with nylon brush seal.</li> <li>Heavy duty floor levelers.</li> <li>3mm PVC Edges</li> <li>High pressure laminate top with optional edge designs</li> <li>Powder coated, welded steel frame</li> <li>Modesty panel and wire trough</li> </ul> <p><b>Desk Builder</b></p> <p>Any of these accessories may be added to suit your environment</p> <ul style="list-style-type: none"> <li>Keyboard Tray with Pencil Drawer</li> <li>Ergonomic Keyboard Tray</li> <li>Pencil Drawer</li> <li>Hanging Pedestals</li> <li>CPU Holder</li> <li>Adjustable CPU Holder</li> <li>Backpack hanger</li> <li>7000 Series Assembly Instructions</li> </ul>	<b>CLT—Keyboard Height</b>			
	520C236	24" X 36" X 26 1/2"	104	735
	520C248	24" X 48" X 26 1/2"	122	842
	520C260	24" X 60" X 26 1/2"	141	969
	520C272	24" X 72" X 26 1/2"	159	1075
	520C336	30" X 36" X 26 1/2"	110	819
	520C348	30" X 48" X 26 1/2"	130	910
	520C360	30" X 60" X 26 1/2"	150	1043
	520C372	30" X 72" X 26 1/2"	169	1169
	<b>CD - Desk Height</b>			
	520D236	24" X 36" X 29 1/2"	110	785
	520D248	24" X 48" X 29 1/2"	128	892
	520D260	24" X 60" X 29 1/2"	147	1019
	520D272	24" X 72" X 29 1/2"	165	1125
	520D336	30" X 36" X 29 1/2"	116	869
	520D348	30" X 48" X 29 1/2"	136	960
	520D360	30" X 60" X 29 1/2"	156	1093
	520D372	30" X 72" X 29 1/2"	175	1219
<b>Printer Stands—Desk Height</b>				
520D224R	24" X 24" X 29 1/2"	80	747	
520D230R	24" X 30" X 29 1/2"	88	760	
520D324R	30" X 24" X 29 1/2"	84	756	
520D330R	30" X 30" X 29 1/2"	92	792	
<b>Options</b> (Please Specify When Ordering)				
Front Edge:	<b>(R) Traditional Roll Edge - Standard</b> , (C) Comfort Edge, (3) 3mm PVC Edge			
Laminate Color:	(NO) Natural Oak, (LG) Light Gray, (GC) Grand Cherry, (MA) Maple, (GN) Grey Nebula (EC) Extend Color Options - Nearly 200 additional colors, patterns & woodgrains.			
3mm PVC Edgeband Color:	<b>(1) Black - Standard</b> , (3) Light Gray, (M) Matching Woodgrain			
Casters:	(C) Casters.... \$56			
Shipping:	<b>Ships (KD) - Freight code 85</b>			
Powder coat color:	<b>(1) Black—Standard</b> , Almond, Light Gray			

### 8000 Series - Steel Base Desk

Description	Model Number	Dimensions D" x W" x H"	Ship Wt	List Price
 <ul style="list-style-type: none"> <li>Featuring Corilam's <i>Easy Access Underside</i> wire management.</li> <li>Heavy duty floor levelers.</li> <li>3mm PVC Edges</li> <li>High pressure laminate top with optional edge designs</li> <li>Powder coated, welded steel frame base with decorative insert panels</li> <li>Modesty panel and wire trays</li> </ul> <p><b>Desk Builder</b></p> <p>Any of these accessories may be added to suit your environment</p> <ul style="list-style-type: none"> <li>Keyboard Tray with Pencil Drawer</li> <li>Ergonomic Keyboard Tray</li> <li>Pencil Drawer</li> <li>Hanging Pedestals</li> <li>CPU Holder</li> <li>Adjustable CPU Holder</li> <li>Backpack hanger</li> <li>Connectors and panels</li> <li>8000 Series Assembly Instructions</li> </ul>	<b>CLT—Keyboard Height</b>			
	526C236	24" X 36" X 26 1/2"	104	699
	526C248	24" X 48" X 26 1/2"	128	736
	526C260	24" X 60" X 26 1/2"	141	821
	526C272	24" X 72" X 26 1/2"	159	872
	526C336	30" X 36" X 26 1/2"	110	753
	526C348	30" X 48" X 26 1/2"	130	774
	526C360	30" X 60" X 26 1/2"	150	865
	526C372	30" X 72" X 26 1/2"	169	936
	<b>CD - Desk Height</b>			
	526D236	24" X 36" X 29 1/2"	110	717
	526D248	24" X 48" X 29 1/2"	128	754
	526D260	24" X 60" X 29 1/2"	147	839
	526D272	24" X 72" X 29 1/2"	165	890
	526D336	30" X 36" X 29 1/2"	116	771
	526D348	30" X 48" X 29 1/2"	136	792
	526D360	30" X 60" X 29 1/2"	156	883
	526D372	30" X 72" X 29 1/2"	175	954
	<b>Printer Stands—Desk Height</b>			
	526D224R	24" X 24" X 29 1/2"	80	655
526D230R	24" X 30" X 29 1/2"	88	668	
526D324R	30" X 24" X 29 1/2"	84	711	
526D330R	30" X 30" X 29 1/2"	92	728	
<b>Options</b> (Please Specify When Ordering)				
Front Edge:	<b>(R) Traditional Roll Edge - Standard</b> , (C) Comfort Edge, (3) 3mm PVC Edge			
Laminate Color:	(NO) Natural Oak, (LG) Light Gray, (GC) Grand Cherry, (MA) Maple, (GN) Grey Nebula (EC) Extend Color Options - Nearly 200 additional colors, patterns & woodgrains.			
3mm PVC Edgeband Color:	<b>(1) Black - Standard</b> , (3) Light Gray, (M) Matching Woodgrain			
Casters:	(C) Casters.... \$56			
Shipping:	<b>Ships (KD) - Freight code 85</b>			
Powder coat color:	<b>(1) Black—Standard</b> , Almond, Light Gray			

### 8000-T Series - Steel Base Desk

Description	Model Number	Dimensions D" x W" x H"	Ship Wt	List Price
 <ul style="list-style-type: none"> <li>Featuring Corilam's <b>Easy Access Top</b> wire management with nylon brush seal.</li> <li>Heavy duty floor levelers.</li> <li>3mm PVC Edges</li> <li>High pressure laminate top with optional edge designs</li> <li>Powder coated, welded steel frame base with decorative insert panels</li> <li>Modesty panel and wire trough</li> </ul> <p><b>Desk Builder</b></p> <p>Any of these accessories may be added to suit your environment</p> <ul style="list-style-type: none"> <li>Keyboard Tray with Pencil Drawer</li> <li>Ergonomic Keyboard Tray</li> <li>Pencil Drawer</li> <li>Hanging Pedestals</li> <li>CPU Holder</li> <li>Adjustable CPU Holder</li> <li>Backpack hanger</li> <li>Connectors and panels</li> <li>8000 Series Assembly Instructions</li> </ul>	<b>CLT—Keyboard Height</b>			
	522C236	24" X 36" X 26 1/2"	104	815
	522C248	24" X 48" X 26 1/2"	122	920
	522C260	24" X 60" X 26 1/2"	141	999
	522C272	24" X 72" X 26 1/2"	159	1105
	522C336	30" X 36" X 26 1/2"	110	869
	522C348	30" X 48" X 26 1/2"	130	958
	522C360	30" X 60" X 26 1/2"	150	1043
	522C372	30" X 72" X 26 1/2"	169	1169
	<b>CD - Desk Height</b>			
	522D236	24" X 36" X 29 1/2"	110	871
	522D248	24" X 48" X 29 1/2"	128	976
	522D260	24" X 60" X 29 1/2"	147	1055
	522D272	24" X 72" X 29 1/2"	165	1161
	522D336	30" X 36" X 29 1/2"	116	925
	522D348	30" X 48" X 29 1/2"	136	1014
	522D360	30" X 60" X 29 1/2"	156	1099
	522D372	30" X 72" X 29 1/2"	175	1225
<p><b>Options</b> (Please Specify When Ordering)</p> <p>Front Edge: (R) Traditional Roll Edge - Standard, (C) Comfort Edge, (3) 3mm PVC Edge</p> <p>Laminate Color: (NO) Natural Oak, (LG) Light Gray, (GC) Grand Cherry, (MA) Maple, (GN) Grey Nebula (EC) Extend Color Options - Nearly 200 additional colors, patterns &amp; woodgrains.</p> <p>3mm PVC Edgeband Color: (1) Black - Standard, (3) Light Gray, (M) Matching Woodgrain</p> <p><b>Ships (KD) - Freight code 85</b> (C) Casters.... \$56</p> <p>Shipping: <b>Ships (KD) - Freight code 85</b></p> <p>Powder coat color: (1) Black—Standard, Almond, Light Gray</p>				

### 8300 Series - Steel Base Desk

Description	Model Number	Dimensions D" x W" x H"	Ship Wt	List Price
-------------	--------------	----------------------------	---------	------------



#### Tables/Desks - Adjustable Height

527A036	20" X 36" X 20"-32"	70	617
527A048	20" X 48" X 20"-32"	90	637
527A060	20" X 60" X 20"-32"	100	728
527A072	20" X 72" X 20"-32"	126	793
527A236	24" X 36" X 20"-32"	72	632
527A248	24" X 48" X 20"-32"	92	652
527A260	24" X 60" X 20"-32"	102	742
527A272	24" X 72" X 20"-32"	128	812
527A336	30" X 36" X 20"-32"	75	686
527A348	30" X 48" X 20"-32"	95	690
527A360	30" X 60" X 20"-32"	105	786
527A372	30" X 72" X 20"-32"	130	876

- Featuring Corilam's *Easy Access Underside* wire management.
- Heavy duty floor levelers.
- 3mm PVC Edges
- High pressure laminate top with optional edge designs
- Powder coated, adjustable height, fully-welded steel frame base
- Modesty panel and wire trough

#### Desk Builder

Any of these accessories may be added to suit your environment

- Keyboard Tray with Pencil Drawer
- Ergonomic Keyboard Tray
- Pencil Drawer
- CPU Holder
- Adjustable CPU Holder
- Backpack hanger

#### Options (Please Specify When Ordering)

Front Edge:	<b>(R) Traditional Roll Edge - Standard</b> , (C) Comfort Edge, (3) 3mm PVC Edge
Laminate Color:	(NO) Natural Oak, (LG) Light Gray, (GC) Grand Cherry, (MA) Maple, (GN) Grey Nebula (EC) Extend Color Options - Nearly 200 additional colors, patterns & woodgrains.
3mm PVC Edgeband Color:	<b>(1) Black - Standard</b> , (3) Light Gray, (M) Matching Woodgrain
Casters:	(C) Casters.... \$56
Shipping:	<b>Ships (KD) - Freight code 85</b>
Powder coat color:	<b>(1) Black—Standard</b> , Almond, Silver

### 8400 Series - Steel Base Desk—Split Top

Description	Model Number	Dimensions D" x W" x H"	Ship Wt	List Price
-------------	--------------	----------------------------	---------	------------

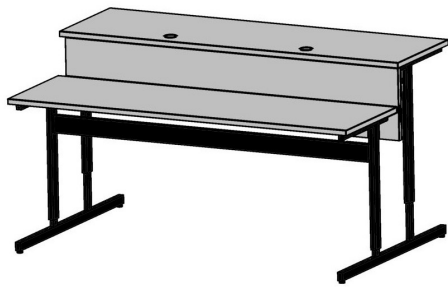

**Tables/Desks - Adjustable Height**

529A036	36" X 36" X 20"-32"	90	935
529A060	36" X 60" X 20"-32"	130	1065
529A072	36" X 72" X 20"-32"	150	1170

- Featuring Corilam's *Easy Access Underside* wire management.
- Heavy duty floor levelers.
- 3mm PVC Edges
- High pressure laminate top with optional edge designs
- Powder coated, adjustable height, fully-welded steel frame base
- Modesty panel and wire trough

**Desk Builder**

Any of these accessories may be added to suit your environment

- Keyboard Tray with Pencil Drawer
- Ergonomic Keyboard Tray
- Pencil Drawer
- CPU Holder
- Adjustable CPU Holder
- Backpack hanger

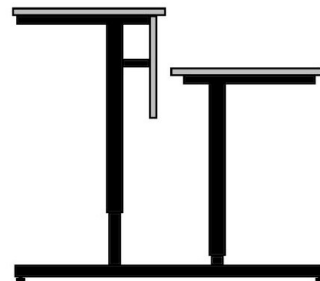

**Options** (Please Specify When Ordering)

Front Edge:	(R) Traditional Roll Edge - Standard, (C) Comfort Edge, (3) 3mm PVC Edge
Laminate Color:	(NO) Natural Oak, (LG) Light Gray, (GC) Grand Cherry, (MA) Maple, (GN) Grey Nebula (EC) Extend Color Options - Nearly 200 additional colors, patterns & woodgrains.
3mm PVC Edgeband Color:	(1) Black - Standard, (3) Light Gray, (M) Matching Woodgrain
Shipping:	<b>Ships (KD) - Freight code 85</b>
Powder coat color:	(1) Black—Standard, Almond, Platinum



### 8500 Series - Steel Base Desk

Description	Model Number	Dimensions D" x W" x H"	Ship Wt	List Price
-------------	--------------	----------------------------	---------	------------



- Featuring Corilam's **optional In-Leg** wire management.
- Heavy duty floor levelers.
- 3mm PVC Edges
- High pressure laminate top with optional edge designs
- Powder coated, adjustable height, fully-welded steel frame base
- Optional modesty panel, wiring tray and grommets

#### Tables/Desks - Adjustable Height

528A036	20" X 36" X 20"-32"	70	450
528A048	20" X 48" X 20"-32"	90	489
528A060	20" X 60" X 20"-32"	100	534
528A072	20" X 72" X 20"-32"	126	564
528A236	24" X 36" X 20"-32"	72	477
528A248	24" X 48" X 20"-32"	92	515
528A260	24" X 60" X 20"-32"	102	569
528A272	24" X 72" X 20"-32"	128	603
528A336	30" X 36" X 20"-32"	75	489
527A348	30" X 48" X 20"-32"	95	533
527A360	30" X 60" X 20"-32"	105	587
527A372	30" X 72" X 20"-32"	130	627

#### Optional Modesty Panel

528MP36	3/4" X 36" X 12"	18	50
528MP48	3/4" X 48" X 12"	24	67
528MP60	3/4" X 60" X 12"	30	83
528MP72	3/4" X 72" X 12"	36	100

#### Desk Builder

Any of these accessories may be added to suit your environment

- Keyboard Tray with Pencil Drawer
- Ergonomic Keyboard Tray
- Pencil Drawer
- CPU Holder
- Adjustable CPU Holder
- Backpack hanger

#### Options (Please Specify When Ordering)

Front Edge:	(R) Traditional Roll Edge - Standard, (C) Comfort Edge, (3) 3mm PVC Edge
Laminate Color:	(NO) Natural Oak, (LG) Light Gray, (GC) Grand Cherry, (MA) Maple, (GN) Grey Nebula (EC) Extend Color Options - Nearly 200 additional colors, patterns & woodgrains.
3mm PVC Edgeband Color:	(1) Black - Standard, (3) Light Gray, (M) Matching Woodgrain
Casters:	(C) Casters.... \$56
Shipping:	<b>Ships (KD) - Freight code 85</b>
Powder coat color:	(1) Silver - Standard, Black, Almond

9000 - T Series - Steel Base Desk

Description	Model Number	Dimensions D" x W" x H"	Ship Wt	List Price
-------------	--------------	----------------------------	---------	------------



Tables/Desks - Adjustable Height

524A236	24" X 36" X 20"-36"	100	735
524A248	24" X 48" X 20"-36"	127	846
524A260	24" X 60" X 20"-36"	140	933
524A272	24" X 72" X 20"-36"	153	986
524A336	30" X 36" X 20"-36"	100	769
524A348	30" X 48" X 20"-36"	127	864
524A360	30" X 60" X 20"-36"	140	957
524A372	30" X 72" X 20"-36"	153	1030

- Featuring Corilam's **Easy Access Top** wire management with nylon brush seal.
- Heavy duty floor levelers.
- High pressure laminate top with optional edge designs
- Adjustable height, powder coated, fully welded steel frame
- Metal wire trough.

**Desk Builder**

Any of these accessories may be added to suit your environment

- Keyboard Tray with Pencil Drawer
- Ergonomic Keyboard Tray
- CPU Holder
- Adjustable CPU Holder
- Book bag hook

**Options** (Please Specify When Ordering)

Front Edge:	(R) Traditional Roll Edge - Standard, (C) Comfort Edge, (3) 3mm PVC Edge
Laminate Color:	(NO) Natural Oak, (MO) Medium Oak, (WN) Walnut, (LG) Light Gray, (GC) Grand Cherry, (MA) Maple ,(GN) Grey Nebula, (BG) Beige Granite, (ES) Ebony Sand  (EC) Extend Color Options - Nearly 200 additional colors, patterns & woodgrains.
Modesty Panel:	(1) Black - Standard, (3) Light Gray, (M) Matching
3mm PVC Edgeband Color:	(1) Black - Standard, (3) Light Gray, (M) Matching Woodgrain
Casters:	(C) Casters.... \$56
Shipping:	<b>Ships (A) Assembled— Freight code 125</b>
Powder coat color:	(1) Black—Standard, Almond, Light Gray

## 2000 Series - Panel Base Desk with Hardwood Edges

Description	Model Number	Dimensions D" x W" x H"	Ship Wt	List Price
 <ul style="list-style-type: none"> <li>Featuring Corilam's <b>Easy Access Top</b> wire management with nylon brush seal.</li> <li>Roll edge high pressure laminate top and pedestals.</li> <li>Hardwood corner moldings.</li> <li>Heavy duty floor levelers.</li> <li>Traditional front roll edge</li> </ul> <p><b>Desk Builder</b></p> <p>Any of these accessories may be added to suit your environment</p> <ul style="list-style-type: none"> <li>Keyboard Tray with Pencil Drawer</li> <li>Ergonomic Keyboard Tray</li> <li>Teacher Desk Return</li> <li>Pencil Drawer</li> <li>Hanging Pedestals</li> <li>CPU Holder</li> <li>Adjustable CPU Holder</li> <li>2000 Series Assembly Instructions</li> </ul>	<b>CLT—Keyboard Height</b>			
	510C236R	24" X 36" X 26 1/2"	88	763
	510C248R	24" X 48" X 26 1/2"	103	870
	510C260R	24" X 60" X 26 1/2"	117	973
	510C272R	24" X 72" X 26 1/2"	132	1056
	510C336R	30" X 36" X 26 1/2"	95	845
	510C348R	30" X 48" X 26 1/2"	111	936
	510C360R	30" X 60" X 26 1/2"	127	1045
	510C372R	30" X 72" X 26 1/2"	143	1148
	<b>CD - Desk Height</b>			
	510D236R	24" X 36" X 29 1/2"	94	834
	510D248R	24" X 48" X 29 1/2"	109	941
	510D260R	24" X 60" X 29 1/2"	123	1044
	510D272R	24" X 72" X 29 1/2"	138	1127
	510D336R	30" X 36" X 29 1/2"	101	916
510D348R	30" X 48" X 29 1/2"	117	1007	
510D360R	30" X 60" X 29 1/2"	133	1116	
510D372R	30" X 72" X 29 1/2"	149	1219	
<b>Printer Stands—Desk Height</b>				
510D224R	24" X 24" X 29 1/2"	79	766	
510D230R	24" X 30" X 29 1/2"	86	804	
510D324R	30" X 24" X 29 1/2"	84	837	
510D330R	30" X 30" X 29 1/2"	92	875	
<b>Options</b> (Please Specify When Ordering)				
Laminate Color:	(NO) Natural Oak, (MO) Medium Oak, (WN) Walnut, (LG) Light Gray (GC) Grand Cherry, (MA) Maple, (GN) Grey Nebula, (BG) Beige Granite, (ES) Ebony Sand (EC) Extend Color Options - Nearly 100 additional colors, patterns & woodgrains.			
Hardwood Mouldings:	(L) Light Finish, (D) Dark Finish			
Casters:	(C) Casters.... \$115			
Shipping:	<b>Ships (KD) - Freight code 85</b>			

### 3000 Series - Panel Base Desk

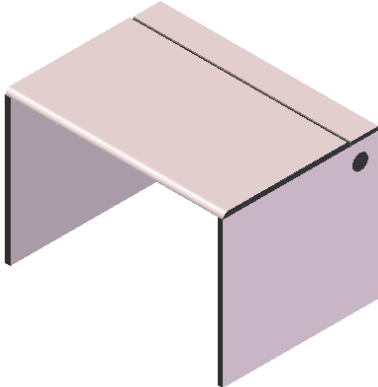
Description	Model Number	Dimensions D" x W" x H"	Ship Wt	List Price
 <ul style="list-style-type: none"> <li>Featuring Corilam's <b>Easy Access Top</b> wire management with nylon brush seal.</li> <li>Heavy duty floor levelers.</li> <li>3mm PVC Edges</li> <li>High pressure laminate top with optional edge designs</li> <li>Wire grommets</li> </ul>	<b>CLT—Keyboard Height</b>			
	511C236	24" X 36" X 26 1/2"	103	811
	511C248	24" X 48" X 26 1/2"	122	918
	511C260	24" X 60" X 26 1/2"	140	988
	511C272	24" X 72" X 26 1/2"	158	1104
	511C336	30" X 36" X 26 1/2"	110	845
	511C348	30" X 48" X 26 1/2"	130	936
	511C360	30" X 60" X 26 1/2"	150	1045
	511C372	30" X 72" X 26 1/2"	169	1148
	<p><b>Desk Builder</b></p> <p>Any of these accessories may be added to suit your environment</p> <ul style="list-style-type: none"> <li>Keyboard Tray with Pencil Drawer</li> <li>Ergonomic Keyboard Tray</li> <li>Teacher Desk Return</li> <li>Pencil Drawer</li> <li>Hanging Pedestals</li> <li>CPU Holder</li> <li>Adjustable CPU Holder</li> <li>3000 Series Assembly Instructions</li> </ul>	<b>CD - Desk Height</b>		
511D236		24" X 36" X 29 1/2"	109	882
511D248		24" X 48" X 29 1/2"	128	989
511D260		24" X 60" X 29 1/2"	146	1059
511D272		24" X 72" X 29 1/2"	164	1175
511D336		30" X 36" X 29 1/2"	116	916
511D348		30" X 48" X 29 1/2"	136	1007
511D360		30" X 60" X 29 1/2"	156	1116
511D372		30" X 72" X 29 1/2"	175	1219
<p><b>Printer Stands—Desk Height</b></p>		511D224R	24" X 24" X 29 1/2"	79
	511D230R	24" X 30" X 29 1/2"	86	804
	511D324R	30" X 24" X 29 1/2"	84	837
	511D330R	30" X 30" X 29 1/2"	92	875
<b>Options</b> (Please Specify When Ordering)				
Front Edge:	<b>(R) Traditional Roll Edge - Standard</b> , (C) Comfort Edge, (3) 3mm PVC Edge			
Laminate Color:	(NO) Natural Oak, (LG) Light Gray, (GC) Grand Cherry, (MA) Maple, (GN) Grey Nebula (EC) Extend Color Options - Nearly 100 additional colors, patterns & woodgrains.			
3mm PVC Edgeband Color:	<b>(1) Black - Standard</b> , (3) Light Gray, (M) Matching Woodgrain			
Casters:	(C) Casters.... \$115			
Shipping:	<b>Ships (KD) - Freight code 85</b>			



### 3000 - R Series - Panel Base Desk

Description	Model Number	Dimensions D" x W" x H"	Ship Wt	List Price
 <ul style="list-style-type: none"> <li>Featuring Corilam's <b>Easy Access Rear</b> wire management.</li> <li>Heavy duty floor levelers.</li> <li>3mm PVC Edges</li> <li>High pressure laminate top with optional edge designs</li> <li>Wire grommets</li> </ul> <p><b>Desk Builder</b></p> <p>Any of these accessories may be added to suit your environment</p> <ul style="list-style-type: none"> <li>Keyboard Tray with Pencil Drawer</li> <li>Ergonomic Keyboard Tray</li> <li>Teacher Desk Return</li> <li>Pencil Drawer</li> <li>Hanging Pedestals</li> <li>CPU Holder</li> <li>Adjustable CPU Holder</li> <li>3000 Series Assembly Instructions</li> </ul>	<b>CLT—Keyboard Height</b>			
	513C236	24" X 36" X 26 1/2"	103	811
	513C248	24" X 48" X 26 1/2"	122	918
	513C260	24" X 60" X 26 1/2"	140	988
	513C272	24" X 72" X 26 1/2"	158	1104
	513C336	30" X 36" X 26 1/2"	110	845
	513C348	30" X 48" X 26 1/2"	130	936
	513C360	30" X 60" X 26 1/2"	150	1045
	513C372	30" X 72" X 26 1/2"	169	1148
	<b>CD - Desk Height</b>			
	513D236	24" X 36" X 29 1/2"	109	882
	513D248	24" X 48" X 29 1/2"	128	989
	513D260	24" X 60" X 29 1/2"	146	1059
	513D272	24" X 72" X 29 1/2"	164	1175
513D336	30" X 36" X 29 1/2"	116	916	
513D348	30" X 48" X 29 1/2"	136	1007	
513D360	30" X 60" X 29 1/2"	156	1116	
513D372	30" X 72" X 29 1/2"	175	1219	
<b>Printer Stands—Desk Height</b>				
513D224R	24" X 24" X 29 1/2"	79	766	
513D230R	24" X 30" X 29 1/2"	86	804	
513D324R	30" X 24" X 29 1/2"	84	837	
513D330R	30" X 30" X 29 1/2"	92	875	
<b>Options</b> (Please Specify When Ordering)				
Front Edge:	<b>(R) Traditional Roll Edge - Standard</b> , (C) Comfort Edge, (3) 3mm PVC Edge			
Laminate Color:	(NO) Natural Oak, (LG) Light Gray, (GC) Grand Cherry, (MA) Maple, (GN) Grey Nebula (EC) Extend Color Options - Nearly 100 additional colors, patterns & woodgrains.			
3mm PVC Edgeband Color:	<b>(1) Black - Standard</b> , (3) Light Gray, (M) Matching Woodgrain			
Casters:	(C) Casters.... \$115			
Shipping:	<b>Ships (KD) - Freight code 85</b>			

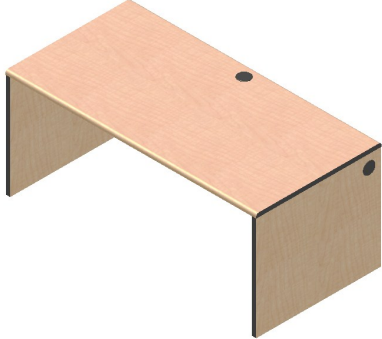
### 4000 Series - Panel Base Desk





Description	Model Number	Dimensions D" x W" x H"	Ship Wt	List Price
 <ul style="list-style-type: none"> <li>Featuring Corilam's <i>Easy Access Underside</i> wire management.</li> <li>Heavy duty floor levelers.</li> <li>3mm PVC Edges</li> <li>High pressure laminate top with optional edge designs</li> <li>Wire grommets</li> </ul> <p><b>Desk Builder</b></p> <p>Any of these accessories may be added to suit your environment</p> <ul style="list-style-type: none"> <li>Keyboard Tray with Pencil Drawer</li> <li>Ergonomic Keyboard Tray</li> <li>Teacher Desk Return</li> <li>Pencil Drawer</li> <li>Hanging Pedestals</li> <li>CPU Holder</li> <li>Adjustable CPU Holder</li> <li>4000 Series Assembly Instructions</li> </ul>	<b>CLT—Keyboard Height</b>			
	512C236	24" X 36" X 26 1/2"	103	779
	512C248	24" X 48" X 26 1/2"	122	888
	512C260	24" X 60" X 26 1/2"	140	967
	512C272	24" X 72" X 26 1/2"	158	1045
	512C336	30" X 36" X 26 1/2"	110	813
	512C348	30" X 48" X 26 1/2"	130	906
	512C360	30" X 60" X 26 1/2"	150	1009
	512C372	30" X 72" X 26 1/2"	169	1089
	<b>CD - Desk Height</b>			
	512D236	24" X 36" X 29 1/2"	109	840
	512D248	24" X 48" X 29 1/2"	128	949
	512D260	24" X 60" X 29 1/2"	146	1028
	512D272	24" X 72" X 29 1/2"	164	1106
	512D336	30" X 36" X 29 1/2"	116	874
512D348	30" X 48" X 29 1/2"	136	967	
512D360	30" X 60" X 29 1/2"	156	1070	
512D372	30" X 72" X 29 1/2"	175	1150	
<b>Printer Stands—Desk Height</b>				
512D224R	24" X 24" X 29 1/2"	79		
512D330R	24" X 30" X 29 1/2"	86		
512D324R	30" X 24" X 29 1/2"	84		
512D330R	30" X 30" X 29 1/2"	92		
<b>Options</b> (Please Specify When Ordering)				
Front Edge:	<b>(R) Traditional Roll Edge - Standard</b> , (C) Comfort Edge, (3) 3mm PVC Edge			
Laminate Color:	(NO) Natural Oak, (LG) Light Gray, (GC) Grand Cherry, (MA) Maple, (GN) Grey Nebula (EC) Extend Color Options - Nearly 100 additional colors, patterns & woodgrains.			
3mm PVC Edgeband Color:	<b>(1) Black - Standard</b> , (3) Light Gray, (M) Matching Woodgrain			
Casters:	(C) Casters.... \$115			
Shipping:	<b>Ships (KD) - Freight code 85</b>			

530 / 531 / 532 - Carrels





Description	Model Number	Dimensions D" x W" x H"	Ship Wt	List Price
	<b>Steel Leg Carrel</b>			
	530SD331 - Starter	30" X 31" X 48"	130	955
	530AD331 - Adder	30" X 31" X 48"	110	783
	<b>Standalone and Starter Unit - All Panel Carrel</b>			
	531SD331 - Starter	30" X 31" X 48"	138	1049
	531AD331 - Adder	30" X 31" X 48"	110	794
	<b>Standalone - Metal T-Leg Carrel w/ 3mm PVC Edge</b>			
	532SD331	30" X 37" X Adjustable	145	882
<ul style="list-style-type: none"> <li>• Stand-Alone and Adder Units.</li> <li>• Heavy duty floor levelers.</li> <li>• High pressure laminate top with optional edge designs</li> <li>• Base options include full height panels, Steel frame, and adjustable height steel frames</li> <li>• Metal wire trough.</li> </ul>				
<p><b>Workcenter Builder</b> Any of these accessories may be added to suit your environment</p> <ul style="list-style-type: none"> <li>• Keyboard Tray with Pencil Drawer</li> <li>• Ergonomic Keyboard Tray</li> <li>• CPU Holder</li> <li>• Adjustable CPU Holder</li> <li>• Book bag hook</li> <li>• Assembly instructions</li> </ul>				
<p><b>Options</b> (Please Specify When Ordering)</p> <p>Front Edge: <b>(R) Traditional Roll Edge - Standard</b>, (C) Comfort Edge, (3) 3mm PVC Edge</p> <p>Laminate Color: (NO) Natural Oak, (LG) Light Gray, (GC) Grand Cherry, (MA) Maple, (GN) Grey Nebula (EC) Extend Color Options - Nearly 200 additional colors, patterns &amp; woodgrains.</p> <p>3mm PVC Edgeband Color: <b>(1) Black - Standard</b>, (3) Light Gray, (M) Matching Woodgrain</p> <p>Shipping: <b>Ships (KD) - Freight code 85</b></p> <p>Powder coat color: <b>(1) Black—Standard</b>, Almond, Silver</p>				





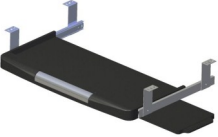

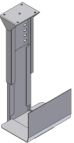
910 / 911 / 912 - Lecturns

Description	Model Number	Dimensions D" x W" x H"	Ship Wt	List Price
	<b>Table Top Lecturn</b>			
	910-5724	17 X24 X 15	26	463
	<b>Pedestal Lecturn (Casters optional)</b>			
	911-2724	17 X 24 X 42	129	762
	<b>Mobile Lecturn (Casters included)</b>			
	912-6025	20 X 25 X 46	138	1155
	<b>Mobile Lecturn / Storage Unit (Casters included)</b>			
	912-6030	30 X 36 X 42	175	2398
<ul style="list-style-type: none"> <li>• Table top, freestanding and mobile units.</li> <li>• Heavy duty floor levelers.</li> <li>• High pressure laminate top with optional edge designs</li> <li>• Easily customizable</li> </ul>				
<p><b>Options</b> (Please Specify When Ordering)</p> <p>Laminate Color: (NO) Natural Oak, (LG) Light Gray, (GC) Grand Cherry, (MA) Maple, (GN) Grey Nebula (EC) Extend Color Options - Nearly 200 additional colors, patterns &amp; woodgrains.</p> <p>3mm PVC Edgeband Color: (1) <b>Black - Standard</b>, (3) Light Gray, (M) Matching Woodgrain</p> <p>Shipping: <b>Ships (A) Assembled– Freight code 125</b></p>				

Computer Accessories

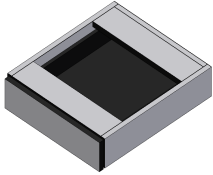
Description	Series	Model Number	Dimensions D" x W" x H"	Ship Wt	List Price
<b>Keyboard Tray with Pencil Drawer</b>					
 <p>Slide-out with retractable mouse tray, left or right. Silent ball bearing slides. Pencil box with cover. Black.</p>	All	550-1100	10 X 22	5	133
<b>Ergonomic Keyboard Tray</b>					
 <p>Slide-out with retractable mouse tray, left or right. Ergonomic adjustments. Black.</p>	All	550-1120	13 X 24	10	258
<b>Monitor Arm</b>					
 <p>Adjusts screen to the most comfortable viewing position. Full range of motion. Cables can be neatly concealed in arm.</p>	All	550-1310			494
<b>Adjustable CPU Holder</b>					
 <p>16 Ga. Metal, black powder coated. Reversible. Mounts right or left. Adjustable width.</p>	All	550-1210	20 X 9 X 22	10	199
<b>Adjustable CPU Holder</b>					
 <p>Fits most CPU's up to 60 lbs and 64" perimeter. Slides out and swivels 360 degrees. Black</p>	All	550-1230	16" Track	10	297

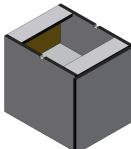
Workspace Accessories

Description	Series	Model Number	Dimensions D" x W" x H"	Ship Wt	List Price
<b>Pencil Drawer</b>  <p>Laminated drawer front. 3mm PVC edgebanding. Black melamine drawer box. Locking option</p>	All	551-1100	20 x 18 x 3	11	328
		551-110L (Locking)	20 x 18 x 3	11	396
<b>Hanging Pedestals</b>   <p>Laminated drawer front. 3mm PVC edgebanding. Black melamine drawer box. Ball bearing slides. Accommodates letter or legal sizes. Locking option</p>	All	<b>Box/File Pedestal</b>			
		551-1200	20 x 16 x 18 1/2	60	798
		551-120L (Locking)	20 x 16 x 18 1/2	60	865
		<b>Door/Shelf Pedestal</b>			
		551-1300	20 x 16 x 18 1/2	50	640
		551-130L (Locking)	20 x 16 x 18 1/2	50	707
<b>Floor Pedestals</b>   <p>Laminated drawer front. 3mm PVC edgebanding. Black melamine drawer box. Ball bearing slides. Accommodates letter or legal sizes. Locking option</p>	All	<b>Box/Box/File Pedestal</b>			
		551-1500	20 x 16 x 28 1/2	95	1077
		551-150L (Locking)	20 x 16 x 28 1/2	95	1142
		<b>File/File Pedestal</b>			
		551-1600	20 x 16 x 28 1/2	90	976
		551-160L (Locking)	20 x 16 x 28 1/2	90	1042
<b>Options</b> (Please Specify When Ordering)					
Laminate Color:	(NO) Natural Oak, (MO) Medium Oak, (WN) Walnut, (LG) Light Gray, (GC) Grand Cherry, (MA) Maple, (GN) Grey Nebula, (BG) Beige Granite, (ES) Ebony Sand				
	(EC) Extend Color Options - Nearly 200 Additional Colors, Patterns & Woodgrains				
3mm PVC Edgeband Color:	<b>(1) Black - Standard</b> , (3) Light Gray, (M) Matching Woodgrain				

Workspace Accessories

Description	Series	Model Number	Dimensions D" x W" x H"	Ship Wt	List Price
-------------	--------	--------------	----------------------------	---------	------------

Mobile Pedestals



Laminated drawer front. 3mm PVC edgebanding. Black melamine drawer box. Ball bearing slides. Accommodates letter or legal sizes. Locking option.

All **Box/Box/File Pedestal**

551-1510	20 x 16 x 28 1/2	95	806
551-151L (Locking)	20 x 16 x 28 1/2	95	854

**File/File Pedestal**

551-1610	20 x 16 x 28 1/2	90	734
551-161L (Locking)	20 x 16 x 28 1/2	90	782



Open Hutch

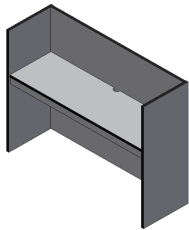

3/4" laminated panels with 3mm PVC edgebanding. Grommet. Light valance. Cork tack board.

All	551-1710	15 x 34 x 36	74	448
	551-1720	15 x 40 x 36	79	505
	551-1730	15 x 46 x 36	84	614
	551-1740	15 x 58 x 36	102	629
	551-1750	15 x 70 x 36	116	665

Hutch with Overhead Door

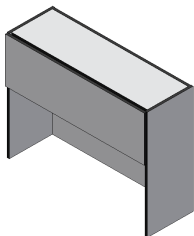

3/4" laminated panels with 3mm PVC banding. Grommet. Light valance. 19" clearance. Cork tack board. 34", 40", and 46" units have one door only.

All	551-1810	15 x 34 x 36	85	653
	551-1820	15 x 40 x 36	92	750
	551-1830	15 x 46 x 36	98	970
	551-1840	15 x 58 x 36	119	1072
	551-1850	15 x 70 x 36	142	1134

Options (Please Specify When Ordering)

Laminate Color:	(NO) Natural Oak, (MO) Medium Oak, (WN) Walnut, (LG) Light Gray, (GC) Grand Cherry, (MA) Maple, (GN) Grey Nebula, (BG) Beige Granite, (ES) Ebony Sand
	(EC) Extend Color Options - Nearly 100 Additional Colors, Patterns & Woodgrains
3mm PVC Edgeband Color:	<b>(1) Black - Standard</b> , (3) Light Gray, (M) Matching Woodgrain

Workspace Accessories

Description	Series	Model Number	Dimensions D" x W" x H"	Ship Wt	List Price
-------------	--------	--------------	----------------------------	---------	------------

**Desk Returns**



Laminated panels match Desk/Tables. Grommet and Cable Support.

2000  
3000  
4000

**Left Return**

551-140L	24 x 48 x 29	70	596
----------	--------------	----	-----

**Right Return**

551-140R	24 x 48 x 29	70	596
----------	--------------	----	-----

**Corner Work Surface**



Freestanding Unit. Laminated panels match Desk/Tables. Grommet and Cable Support.

3000  
4000  
7000

**3000, 4000 Series**

552-1400	30 x 48 x 48	116	1319
----------	--------------	-----	------

**7000 Series**

552-1410	30 x 48 x 48	116	1319
----------	--------------	-----	------

Options (Please Specify When Ordering)



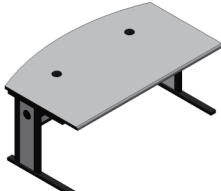
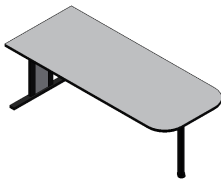
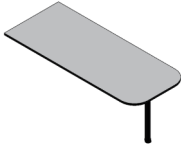

Laminate Color: (NO) Natural Oak, (MO) Medium Oak, (WN) Walnut, (LG) Light Gray, (GC) Grand Cherry, (MA) Maple, (GN) Grey Nebula, (BG) Beige Granite, (ES) Ebony Sand  
(EC) Extend Color Options - Nearly 100 Additional Colors, Patterns & Woodgrains

3mm PVC Edgeband Color: **(1) Black - Standard**, (3) Light Gray, (M) Matching Woodgrain

Workspace Accessories

Description	Series	Model Number	Dimensions D" x W" x H"	Ship Wt	List Price
<b>Bow Front Workstation</b>					
 <p>Same specifications as our 8000-E Series with a curved high pressure laminate top.</p>	8000	107-D672	36 x 72 x 29 1/2	130	1280
<b>Peninsula Connectors</b>					
 <p>Full metal leg with decorative insert panel. High pressure laminate top with 3mm PVC banding. Full radius end. Metal leg support.</p>	8000	113-D248	24 x 48 x 29 1/2	80	620
		113-D260	24 x 60 x 29 1/2	85	685
		113-D272	24 x 72 x 29 1/2	90	756
		113-D348	30 x 48 x 29 1/2	85	685
		113-D360	30 x 60 x 29 1/2	90	708
 <p>High pressure laminate top with 3mm PVC banding. Full radius end. Metal leg support. Designed to connect to other workstations.</p>	8000	112-D242	24 x 42 x 29 1/2	80	539
		112-D248	24 x 48 x 29 1/2	85	539
		112-D272	24 x 72 x 29 1/2	90	637
		112-D342	30 x 42 x 29 1/2	85	566
		112-D348	30 x 48 x 29 1/2	90	566
112-D372	30 x 72 x 29 1/2	95	666		
<b>Options (Please Specify When Ordering)</b>					
Laminate Color:	(NO) Natural Oak, (MO) Medium Oak, (WN) Walnut, (LG) Light Gray, (GC) Grand Cherry, (MA) Maple, (GN) Grey Nebula, (BG) Beige Granite, (ES) Ebony Sand				
	(EC) Extend Color Options - Nearly 100 Additional Colors, Patterns & Woodgrains				
3mm PVC Edgeband Color:	<b>(1) Black - Standard</b> , (3) Light Gray, (M) Matching Woodgrain				

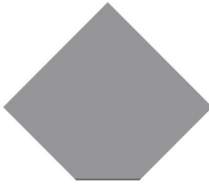
Connector and Panel Accessories

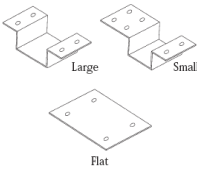
Description	Series	Model Number	Dimensions D" x W" x H"	Ship Wt	List Price	
<b>Center Partition Panel</b>						
 <p>3mm PVC banded melamine panel. Heavy duty floor levelers.</p>	2000	552-110C	28 x 1 x 25 1/2	21	151	
	3000	552-110D	28 x 1 x 28 1/2	23	162	
	4000					
<b>Narrow Side Panel</b>						
 <p>3mm PVC banded melamine panel. Heavy duty floor levelers. Narrow depth</p>	<b>Left Panel</b>					
	3000	552-12CL	28 x 1 x 25 1/2	13	146	
	4000	552-12DL	28 x 1 x 28 1/2	14	154	
	<b>Right Panel</b>					
		552-12CR	28 x 1 x 25 1/2	13	146	
		552-12DR	28 x 1 x 28 1/2	14	154	
<b>Corner Work Surface Connecting Top</b>						
 <p>Connecting laminated top. Corner leg support. Grommet</p>	3000	552-1300	30 x 48 x 48	116	790	
	4000					
	7000	552-1310	30 x 48 x 48	116	790	
<b>90 Degree Angle Connector</b>						
 <p>Matching edge profile. Cables Support. Grommet.</p>	3000	552-1500	21 x 70	67	162	
	4000					
	7000	552-1510	21 x 70	67	153	
<b>Connecting Plates</b>						
 <p>Steel powder coated black. Connect various workstation sections.</p>	ALL	552-1710	Large	10	29	
		552-1720	Small	10	29	
		552-1730	Flat	10	18	
Options (Please Specify When Ordering)						
Laminate Color:	(NO) Natural Oak, (MO) Medium Oak, (WN) Walnut, (LG) Light Gray, (GC) Grand Cherry, (MA) Maple, (GN) Grey Nebula, (BG) Beige Granite, (ES) Ebony Sand					
	(EC) Extend Color Options - Nearly 100 Additional Colors, Patterns & Woodgrains					
3mm PVC Edgeband Color:	<b>(1) Black - Standard</b> , (3) Light Gray, (M) Matching Woodgrain					



Connector and Panel Accessories

Description	Series	Model Number	Dimensions D" x W" x H"	Ship Wt	List Price
-------------	--------	--------------	----------------------------	---------	------------

**Bridge Connector**

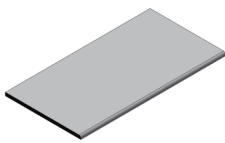

High pressure laminate work surface. Includes connecting plates

552-1600	24 x 46	35	213
----------	---------	----	-----

**45 Degree Angle Connector**

Matching edge profile. Grommet

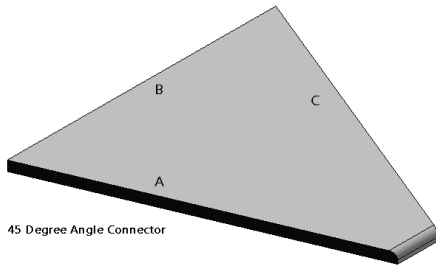

45 Degree Angle Connector

3000	552-1520	30 x 27 x 30	35	88
4000				
7000	552-1535	24 x 27 x 24	25	88
8000				
9000				

**22 1/2 Degree Angle Connector**

Matching edge profile. Grommet

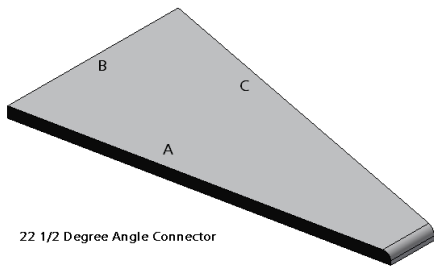

22 1/2 Degree Angle Connector

3000	552-1540	30 x 16 x 30	25	56
4000				
7000	552-1555	24 x 16 x 24	15	56
8000				
9000				

Options (Please Specify When Ordering)

Front Edge:	(R) Traditional Roll Edge - Standard, (C) Comfort Edge, (3) 3mm PVC Edge
Laminate Color:	(NO) Natural Oak, (MO) Medium Oak, (WN) Walnut, (LG) Light Gray, (GC) Grand Cherry, (MA) Maple, (GN) Grey Nebula, (BG) Beige Granite, (ES) Ebony Sand
	(EC) Extend Color Options - Nearly 100 Additional Colors, Patterns & Woodgrains
3mm PVC Edgeband Color:	(1) Black - Standard, (3) Light Gray, (M) Matching Woodgrain

Electrical Accessories

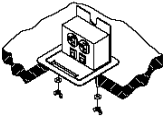
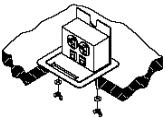
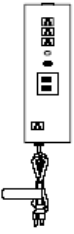
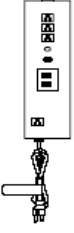
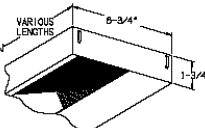
Description	Model Number	Dimensions D" x W" x H"	Ship Wt	List Price
<p><b>Interact, Jr.</b></p>  <ul style="list-style-type: none"> <li>• Table top up</li> <li>• 15 Amp / 125 V</li> <li>• 1 RJ-11 Voice Jack</li> <li>• 1 RU-45 Data Jack</li> <li>• 2 Electrical Circuits</li> <li>• 6' Molded Plug Cord Set</li> </ul>	554-1010			290
<p><b>Interact, Jr.</b></p>  <ul style="list-style-type: none"> <li>• Table top up</li> <li>• 15 Amp / 125 V</li> <li>• 2 RU-45 Data Jack</li> <li>• 2 Electrical Circuits</li> <li>• 6' Molded Plug Cord Set</li> </ul>	554-1020			290
<p><b>Corner Power Column</b></p>  <ul style="list-style-type: none"> <li>• 15 Amp / 125 V</li> <li>• 1 RJ-11 Voice Jack</li> <li>• 1 RJ-45 Data Jack</li> <li>• 3 Electrical Circuits in Face</li> <li>• 1 Electrical Circuit in Top (for task lighting connection)</li> <li>• 6' Molded Plug Cord Set</li> </ul>	554-1110			468
<p><b>Corner Power Column</b></p>  <ul style="list-style-type: none"> <li>• 15 Amp / 125 V</li> <li>• 2 RJ-45 Data Jack</li> <li>• 3 Electrical Circuits in Face</li> <li>• 1 Electrical Circuit in Top (for task lighting connection)</li> <li>• 6' Molded Plug Cord Set</li> </ul>	554-1120			468
<p><b>Task Lighting</b></p>  <ul style="list-style-type: none"> <li>• 108" Center Mount Cord</li> <li>• Rocker Switch</li> <li>• Thermally Protected Ballast</li> </ul>	554-1210	27 1/2" Task Light		234
	554-1220	33 1/2" Task Light		244
	554-1230	45 1/2" Task Light		258

## Model 611 / 612—Adjustable Height

Featuring Corilam's *Fully Welded* powder coated steel frame with high pressure laminate top. Additional charge may apply for Almond and Silver Base for quantities less than (25) twenty-five.



### 611— Adjustable Height C-Leg Base

### 612— Adjustable Height T-Leg Base

**High Pressure Laminate Top:**  
Traditional Post-Formed "Roll Edge" is Standard

- (61X-B) **Black** Powder Coated Frame (**Standard**)
- (61X-A) Almond Powder Coated Frame
- (61X-G) Light Gray Powder Coated Frame

			611- C-Leg 612 - T-Leg	
Model Number	Dimensions (D" x W")	Ship Wt.	List Price	Cubic Ft
XXX-X036	20" X 36"	45	375	9
XXX-X048	20" X 48"	55	407	12
XXX-X060	20" X 60"	64	445	15
XXX-X072	20" X 72"	69	470	18
XXX-X236	24" X 36"	54	397	11
XXX-X248	24" X 48"	65	429	15
XXX-X260	24" X 60"	76	474	18
XXX-X272	24" X 72"	86	502	22
XXX-X336	30" X 36"	66	407	14
XXX-X348	30" X 48"	82	486	18
XXX-X360	30" X 60"	97	489	23
XXX-X372	30" X 72"	102	522	28
XXX-XT42	21" x 42" Trapezoid	55	470	14
XXX-XT80	40" x 80" Trapezoid	125	7772	25
XXX-XR42	42" Round	75	662	20
XXX-XR48	48" Round	92	662	27

#### Options (Please Specify When Ordering)

Front Edge: (R) **Traditional Roll Edge - Standard**, (C) Comfort Edge, (3) 3mm PVC Edge  
 Laminate Color: (NO) Natural Oak, (LG) Light Gray, (GC) Grand Cherry, (MA) Maple, (GN) Grey Nebula  
 (EC) Extend Color Options - Nearly 200 additional colors, patterns & woodgrains.  
 3mm PVC Edgeband Color: (1) **Black - Standard**, (3) Light Gray, (M) Matching Woodgrain  
 Shipping: **Ships (A) Assembled—Freight code 125**  
 Powder coat color: (1) **Black—Standard**, Almond, Light Gray

## Model 615 - Adjustable Height

Featuring Corilam's black powder coated steel frame with chrome lower adjustable legs. Includes high pressure laminate top.



### 615- Adjustable Height T-Leg Base

High Pressure Laminate Top:  
Traditional Post-Formed "Roll Edge" is Standard

			615 - T-Leg	
Model Number	Dimensions (D" x W")	Ship Wt.	List Price	Cubic Ft
615-B036	20" X 36"	45	293	9
615-B048	20" X 48"	55	320	12
615-B060	20" X 60"	64	350	15
615-B072	20" X 72"	69	370	18
615-B236	24" X 36"	54	311	11
615-B248	24" X 48"	65	338	15
615-B260	24" X 60"	76	374	18
615-B272	24" X 72"	86	396	22
615-B336	30" X 36"	66	320	14
615-B348	30" X 48"	82	391	18
615-B360	30" X 60"	97	385	23
615-B372	30" X 72"	102	412	28
615-BR42	42" Round	75	525	20
615-BR48	48" Round	92	525	27

#### Options (Please Specify When Ordering)

Front Edge: (R) Traditional Roll Edge - Standard, (C) Comfort Edge, (3) 3mm PVC Edge  
 Laminate Color: (NO) Natural Oak, (LG) Light Gray, (GC) Grand Cherry, (MA) Maple, (GN) Grey Nebula  
 (EC) Extend Color Options - Nearly 200 additional colors, patterns & woodgrains.  
 3mm PVC Edgeband Color: (1) Black - Standard, (3) Light Gray, (M) Matching Woodgrain  
 Casters: (C) Casters.... \$56  
 Shipping: Ships (KD) - Freight code 85

### Model 139—Fixed Height

Featuring Corilam's **Fully Welded** powder coated steel frames with high pressure laminate tops. Additional charge may apply for Almond and Light Gray for quantities less than (25) twenty-five.

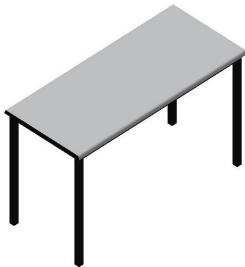

#### 139 - 30" Fixed Height Base

**High Pressure Laminate Top:**  
Traditional Post-Formed "Roll Edge" is Standard for all Square & Rectangular Tops

- (139-B) **Black** Powder Coated Frame (**Standard**)
- (139-A) Almond Powder Coated Frame
- (139-L) Gray Powder Coated Frame

			139 - Fixed Ht Base	
Model Number	Dimensions (D" x W")	Ship Wt.	List Price	Cubic Ft
139-X060	20" X 60"	59	473	15
139-X072	20" X 72"	69	506	18
139-X248	24" X 48"	58	461	13
139-X254	24" X 54"	64	496	15
139-X260	24" X 60"	71	496	17
139-X272	24" X 72"	83	533	20
139-X360	30" X 60"	86	528	21
139-X372	30" X 72"	100	585	25
139-X660	36" X 60"	102	620	25
139-X672	36" X 72"	119	668	30
139-X872	48" X 72"	152	849	40
139-XR42	42" Round	72	664	24
139-XR48	48" Round	90	664	30
139-XR60	60" Round	122	864	42
139-XM48	48" Half Round	58	493	13
139-XM60	60" Half Round	86	556	21
139-XT32	20" x 32" Trapezoid	45	394	12
139-XT48	24" x 48" Trapezoid	58	493	13
139-XT60	30" x 60" Trapezoid	86	549	21

Custom sizes, laminates, edges and specialty powder coat finishes are available upon request. Contact us for additional details and pricing.  
Single and double book boxes may be added to any table.

#### Options (Please Specify When Ordering)

Front Edge: **(R) Traditional Roll Edge - Standard**, (C) Comfort Edge, (3) 3mm PVC Edge

Laminate Color: (NO) Natural Oak, (MO) Medium Oak, (LG) Light Gray, (GC) Grand Cherry, (MA) Maple, (GN) Grey Nebula, (BG) Beige Granite, (ES) Ebony Sand

(EC) Extend Color Options - Nearly 200 additional colors, patterns & woodgrains.

3mm PVC Edgeband Color: **(1) Black - Standard**, (2) White, (3) Fog, (4) Slate, (5) Brown, (6) Almond

Powder Coat Color: **(1) Black - Standard**, Almond, Light Gray

Casters: (C) Casters - 2 Locking, 2 Non-Locking - Add \$56

Shipping: **Ships (A) Assembled - Freight code 125**

## Model 140 - Fixed Height

Featuring Corilam's **Fully Welded** powder coated steel frames with high pressure laminate tops. Additional charge may apply for Almond and Gray for quantities less than (25) twenty-five.

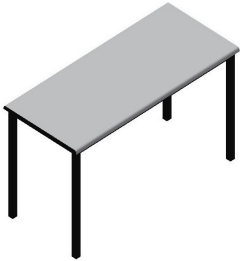

### 140 - Adjustable Height Base 20-36"

**High Pressure Laminate Top:**  
Traditional Post-Formed "Roll Edge" is Standard for all Square & Rectangular Tops

- (140-B) **Black** Powder Coated Frame (**Standard**)
- (140-A) Almond Powder Coated Frame
- (140-L) Gray Powder Coated Frame

			140 - Fixed Ht Base	
Model Number	Dimensions (D" x W")	Ship Wt.	List Price	Cubic Ft
140-X060	20" X 60"	59	545	15
140-X072	20" X 72"	69	584	18
140-X248	24" X 48"	58	522	13
140-X254	24" X 54"	64	557	15
140-X260	24" X 60"	71	569	17
140-X272	24" X 72"	83	613	20
140-X360	30" X 60"	86	604	21
140-X372	30" X 72"	100	668	25
140-X660	36" X 60"	102	698	25
140-X672	36" X 72"	119	758	30
140-X872	48" X 72"	152	881	40
140-XR42	42" Round	72	761	24
140-XR48	48" Round	90	761	30
140-XR60	60" Round	122	939	42
140-XM48	48" Half Round	58	554	13
140-XM60	60" Half Round	86	633	21
140-XT32	20" x 32" Trapezoid	45	450	12
140-XT48	24" x 48" Trapezoid	58	554	13
140-XT60	30" x 60" Trapezoid	86	633	21

Custom sizes, laminates, edges and specialty powder coat finishes are available upon request. Contact us for additional details and pricing.  
Single and double book boxes may be added to any table.

#### Options (Please Specify When Ordering)

Front Edge: **(R) Traditional Roll Edge - Standard**, (C) Comfort Edge, (3) 3mm PVC Edge

Laminate Color: (NO) Natural Oak, (MO) Medium Oak, (LG) Light Gray, (GC) Grand Cherry, (MA) Maple, (GN) Grey Nebula, (BG) Beige Granite, (ES) Ebony Sand

(EC) Extend Color Options - Nearly 200 additional colors, patterns & woodgrains.

3mm PVC Edgeband Color: **(1) Black - Standard**, (2) White, (3) Fog, (4) Slate, (5) Brown, (6) Almond

Powder Coat Color: **(1) Black - Standard**, (A) Almond, (G) Light Gray

Casters: (C) Casters - 2 Locking, 2 Non-Locking - Add \$56

Shipping: **Ships (A) Assembled - Freight code 125**

## Model 143 - Wood Base Tables with Standard HPL tops

Featuring Corilam's fixed height *Hardwood Frame* with a medium oak stain.  
Includes high pressure laminate tops, with optional edge options, and adjustable levelers.



### 143-0 30" Fixed Height Wood

**High Pressure Laminate Top:**  
Traditional Post-Formed "Roll Edge" is Standard

**Additional Fixed Height Options Available** (Call for Pricing)

- (143-4) 34" Fixed Height Table
- (143-8) 28" Fixed Height Table
- (143-7) 27" Fixed Height Table
- (143-6) 26" Fixed Height Table

			143 - Wood Base	
Model Number	Dimensions (D" x W")	Ship Wt.	List Price	Cubic Ft
143-0060	20" X 60"	63	576	5
143-0072	20" X 72"	69	616	6
143-0248	24" X 48"	64	564	5
143-0254	24" X 54"	70	578	5
143-0260	24" X 60"	76	585	6
143-0272	24" X 72"	87	630	7
143-0360	30" X 60"	90	625	7
143-0372	30" X 72"	103	706	9
143-0636	36" X 60"	103	731	9
143-0672	36" X 72"	119	793	11
143-0460	42" X 60"	117	793	10
143-0472	42" X 72"	135	873	12
143-0860	48" X 60"	130	793	12
143-0872	48" X 72"	151	873	14
143-042R	42" Round	75	777	7
143-048R	48" Round	92	777	9

Custom sizes, laminates, edges and specialty finishes are available upon request. Contact us for additional details and pricing.

**Options** (Please Specify When Ordering)

Front Edge: **(R) Traditional Roll Edge - Standard**, (C) Comfort Edge, (3) 3mm PVC Edge

Laminate Color: (NO) Natural Oak, (MO) Medium Oak, (LG) Light Gray, (GC) Grand Cherry, (MA) Maple, (GN) Grey Nebula, (BG) Beige Granite, (ES) Ebony Sand

(EC) Extend Color Options - Nearly 200 additional colors, patterns & woodgrains.

3mm PVC Edgeband Color: **(1) Black - Standard**, (3) Light Gray, (M) Matching Woodgrain

Accessories: (R) Rubber Boots - Set of 4 - Add \$18 (P) Power - Contact For Pricing  
(B) Book Compartments - (2) - Add \$ 130

Shipping: **Ships (KD) - Freight code 85**



## Model 143 - Wood Base Tables with Chemical Resistant Surfaces

Featuring Corilam's fixed height *Hardwood Frame* with a medium oak stain.  
Includes optional surfaces to meet your classroom or laboratory needs and heavy duty levelers.



### 143-0 30" Fixed Height Wood

#### Chemical Resistant Surfaces

Additional Fixed Height Option Available (Call for Pricing)

- (143-4) 34" Fixed Height Table
- (143-8) 28" Fixed Height Table
- (143-7) 27" Fixed Height Table
- (143-6) 26" Fixed Height Table

Model Number	Dimensions (D" x W")	Cubic Ft.	Chemsurf		Phenolic (P)		Epoxy (E) <sup>1</sup>		Durasurf Powder Coated MDF (D) <sup>2</sup>	
			List Price	Ship Wt	List Price	Ship Wt	List Price	Ship Wt	List Price	Ship Wt
143-0060	20" X 60"	5	632	63	789	72	-	-	566	63
143-0072	20" X 72"	6	683	69	888	83	-	-	619	69
143-0248	24" X 48"	5	618	64	858	72	1040	112	554	64
143-0254	24" X 54"	5	638	70	852	79	1112	124	566	70
143-0260	24" X 60"	6	652	76	859	86	1198	136	590	76
143-0272	24" X 72"	7	710	87	972	99	1379	159	650	87
143-0360	30" X 60"	7	709	90	986	102	1410	165	651	90
143-0372	30" X 72"	9	806	103	1138	118	1647	193	735	103
143-0636	36" X 60"	9	831	103	1165	118	1674	193	762	103
143-0672	36" X 72"	11	913	119	1635	137	1933	227	840	119
143-0460	42" X 60"	8	927	117	1388	134	-	-	851	117
143-0472	42" X 72"	10	1033	135	1636	156	-	-	948	135
143-0860	48" X 60"	9	927	130	1388	150	2066	250	851	130
143-0872	48" X 72"	12	1033	151	1636	175	2405	295	948	151
143-042R	42" Round	7	884	75	1387	112	-	-	779	75
143-048R	48" Round	9	884	92	1387	125	-	-	779	92

<sup>1</sup> Call for pricing for all sizes where order quantity is less than (12) twelve.

#### Options (Please Specify When Ordering)

<sup>2</sup> No min quantity for 24 x 54 or 24 x 60. Call for pricing for all other sizes where quantity is less than (25) twenty-five.

Front Edge: (R) Traditional Roll Edge  
(3) 3mm PVC Edge—1/8" round-over  
(P) Phenolic—Beveled  
(E) Epoxy—1/2" radius edges & 1.5" radius corners  
(D) Durasurf™ Epoxy Powder Coated MDF—1/2" radius edges & 1.5" radius corners

Surface Color: (BLC) Black  
(CCC) Custom Chemsurf. Contact for Pricing  
(CCP) Custom Phenolic. Contact for Pricing

3mm PVC Edgeband Color: **(1) Black - Standard**

Accessories: (R) Rubber Boots - Set of 4 - Add \$18 (P) Power—TBD based on spec  
(B) Book Compartments - (2) - Add \$ 130

Shipping: **Ships (KD) - Freight code 85**

## Model 139 - Fixed Height Tables with Chemical Resistant Surfaces

Featuring Corilam's **Fully Welded** black powder coated steel frames .  
Includes optional surfaces to meet your classroom or laboratory needs.  
Additional charge may apply for Almond and Silver Base for quantities less than (25) twenty-five.

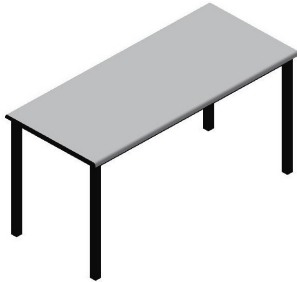

### 139 - 30" Fixed Height

#### Chemical Resistant Surfaces

- (139-B) **Black** Powder Coated Frame (**Standard**)
- (139-A) Almond Powder Coated Frame
- (139-G) **Gray** Powder Coated Frame

Model Number	Dimensions (D" x W")	Cubic Ft.	Chemsurf		Phenolic (P)		Durasurf Powder Coated MDF (D) <sup>1</sup>	
			List Price	Ship Wt	List Price	Ship Wt	List Price	Ship Wt
139-X060	20" X 60"	5	529	59	686	68	463	59
139-X072	20" X 72"	6	573	69	778	80	509	69
139-X248	24" X 48"	5	514	58	754	66	450	58
139-X254	24" X 54"	5	555	64	769	73	483	64
139-X260	24" X 60"	6	562	71	769	81	500	71
139-X272	24" X 72"	7	611	83	873	95	551	83
139-X360	30" X 60"	7	610	86	887	98	552	86
139-X372	30" X 72"	9	685	100	1017	115	614	100
139-X636	36" X 60"	9	714	102	1048	117	645	102
139-X672	36" X 72"	11	787	119	1509	137	714	119
139-X460	42" X 60"	8	882	117	1343	134	806	117
139-X472	42" X 72"	10	985	135	1588	156	900	135
139-X860	48" X 60"	9	882	130	1343	150	806	130
139-X872	48" X 72"	12	985	152	1588	176	900	152
139-X42R	42" Round	7	771	72	1274	105	667	72
139-X48R	48" Round	9	771	90	1274	122	667	90

<sup>1</sup> No min quantity for 24 x 54. Call for pricing for all other sizes where quantity is less than (25) twenty-five.

#### Options (Please Specify When Ordering)

Front Edge:	(R) Traditional Roll Edge (3) 3mm PVC Edge—1/8" round-over (P) Phenolic—Beveled (E) Epoxy—1/2" radius edges & 1.5" radius corners (D) Durasurf™ Epoxy Powder Coated MDF—1/2" radius edges & 1.5" radius corners
Surface Color:	(BLC) Black (CCC) Custom Chemsurf. Contact for Pricing (CCP) Custom Phenolic. Contact for Pricing
3mm PVC Edgeband Color:	<b>(1) Black - Standard</b>
Shipping:	<b>Ships (A) Assembled - Freight code 125</b>
Powder coat color:	<b>(1) Black—Standard, Almond, Light Gray</b>

## Model 140 - Adjustable Height Tables with Chemical Resistant Surfaces

Featuring Corilam's *Fully Welded* powder coated steel frames .  
Includes optional surfaces to meet your classroom or laboratory needs.  
Additional charge may apply for Almond and Silver Base for quantities less than (25) twenty-five.

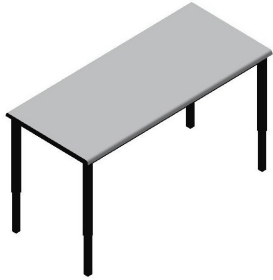

### 140 - 20"-36" Adjustable Height

#### Chemical Resistant Surfaces

- (140-B) **Black** Powder Coated Frame (Standard)
- (140-A) Almond Powder Coated Frame
- (140-G) Gray Powder Coated Frame

Model Number	Dimensions (D" x W")	Cubic Ft.	Chemsurf		Phenolic (P)		Durasurf Powder Coated MDF (D) <sup>1</sup>	
			List Price	Ship Wt	List Price	Ship Wt	List Price	Ship Wt
140-X060	20" X 60"	5	601	59	758	68	535	59
140-X072	20" X 72"	6	651	69	856	80	587	69
140-X248	24" X 48"	5	575	58	815	66	511	58
140-X254	24" X 54"	5	616	64	830	73	544	64
140-X260	24" X 60"	6	634	71	841	81	572	71
140-X272	24" X 72"	7	692	83	954	95	632	83
140-X360	30" X 60"	7	687	86	964	98	629	86
140-X372	30" X 72"	9	767	100	1099	115	696	100
140-X636	36" X 60"	9	797	102	1131	117	728	102
140-X672	36" X 72"	11	878	119	1600	137	805	119
140-X460	42" X 60"	8	910	117	1371	134	834	117
140-X472	42" X 72"	10	1014	135	1617	156	929	135
140-X860	48" X 60"	9	910	130	1371	150	834	130
140-X872	48" X 72"	12	1014	152	1617	176	929	152
140-X42R	42" Round	7	868	72	1371	105	763	72
140-X48R	48" Round	9	868	90	1371	122	763	90



#### Options (Please Specify When Ordering)

<sup>1</sup> No min quantity for 24 x 54. Call for pricing for all other sizes where quantity is less than (25) twenty-five.

Front Edge:	(R) Traditional Roll Edge (3) 3mm PVC Edge—1/8" round-over (P) Phenolic—Beveled (E) Epoxy—1/2" radius edges & 1.5" radius corners (D) Durasurf™ Epoxy Powder Coated MDF—1/2" radius edges & 1.5" radius corners
Surface Color:	(BLC) Black (CCC) Custom Chemsurf. Contact for Pricing (CCP) Custom Phenolic. Contact for Pricing
3mm PVC Edgeband Color:	<b>(1) Black - Standard</b>
Shipping:	<b>Ships (A) Assembled—Freight code 125</b>
Powder coat color:	<b>(1) Black—Standard, Almond, Light Gray</b>

## Model 660 / 661 / 662—Drafting & Graphic Arts Tables

Featuring Corilam's *Fully Welded* powder coated steel frames.  
Additional charge may apply for Almond and Light Gray for quantities less than (25) twenty-five.

Description	Model Number	Tilting Surface	Table Dimensions D" x W" x H"	Ship Wt	List Price
<b>Full Tilting Drafting Surface</b>					
	660-D336	36"	30" X 36" X 30"	60	717
	660-D342	42"	30" X 42" X 30"	65	797
	660-D348	48"	30" X 48" X 30"	70	827
	660-A336	36"	30" X 36" X 20" - 36"	60	631
	660-A342	42"	30" X 42" X 20" - 36"	65	706
	660-A348	48"	30" X 48" X 20" - 36"	70	728
<b>Split Tilting Drafting Worksurface</b>					
	661-D336	24"	30" X 36" X 30"	65	1070
	661-D342	30"	30" X 42" X 30"	70	1190
	661-D348	24"	30" X 48" X 30"	75	1222
	661-D360	30"	30" X 60" X 30"	85	1322
	661-D372	36"	30" X 72" X 30"	102	1424
	661-A336	24"	30" X 36" X 20" - 36"	65	942
	661-A342	30"	30" X 42" X 20" - 36"	70	1049
	661-A348	24"	30" X 48" X 20" - 36"	75	1078
	661-A360	30"	30" X 60" X 20" - 36"	85	1182
	661-A372	36"	30" X 72" X 20" - 36"	102	1285
<b>Split Tilting Drafting Surface w/ Wire Management</b>					
	662-D336	24"	30" X 36" X 30"	92	1334
	662-D342	30"	30" X 42" X 30"	97	1464
	662-D348	24"	30" X 48" X 30"	112	1501
	662-D360	30"	30" X 60" X 30"	130	1625
	662-D372	36"	30" X 72" X 30"	156	1750
	662-A336	24"	30" X 36" X 20" - 36"	92	1173
	662-A342	30"	30" X 42" X 20" - 36"	97	1288
	662-A348	24"	30" X 48" X 20" - 36"	112	1319
	662-A360	30"	30" X 60" X 20" - 36"	130	1452
	662-A372	36"	30" X 72" X 20" - 36"	156	1582
<b>Options (Please Specify When Ordering)</b>					
Laminate Color:	(NO) Natural Oak, (MO) Medium Oak, (LG) Light Gray, (GC) Grand Cherry, (MA) Maple, (GN) Grey Nebula, (BG) Beige Granite, (ES) Ebony Sand				
	(EC) Extend Color Options - Nearly 200 additional colors, patterns & woodgrains.				
3mm PVC Edgeband Color:	<b>(1) Black - Standard</b> , (3) Light Gray, (M) Matching Woodgrain				
Shipping:	<b>Ships (A) Assembled—Freight code 125</b>				
Powder coat color:	<b>(1) Black—Standard</b> , Almond, Light Gray				
<b>Accessories ( See Accessories Section for Additional Information)</b>					
Keyboard Tray with Pencil Drawer	Adjustable CPU Holder	Hanging Hook			
Ergonomic Keyboard Tray	Pencil Drawer	Monitor Arm			

## Model 616 - Adjustable Height Activity Tables

Featuring Corilam's black powder coated upper legs with adjustable (20"-30"), chrome plated low leg inserts and nylon glide. Includes 1-1/8" thick high pressure laminate top.



616- Adjustable Height Activity Table Base

			616 - Activity	
Model Number	Dimensions (D" x W")	Ship Wt.	List Price	
616-B236	24" X 36"	43	211	
616-B248	24" X 48"	59	223	
616-B260	24" X 60"	64	252	
616-B272	24" X 72"	79	281	
616-B336	30" X 30"	44	220	
616-B348	30" X 48"	62	252	
616-B360	30" X 60"	80	293	
616-B372	30" X 72"	98	311	
616-B648	36" X 36"	70	251	
616-B636	36" X 48"	75	281	
616-B660	36" X 60"	80	311	
616-B672	36" X 72"	95	336	
616-B848	48" X 48"	85	302	
616-BR36	36" Round	52	251	
616-BR42	42" Round	66	302	
616-BR48	48" Round	85	302	
616-BR60	60" Round	105	450	
616-BT48	24" X 48" Trapezoid	41	223	
616-BT60	30" X 60" Trapezoid	59	293	
616-BH48	48" X 72" Kidney	110	454	
616-BH60	60" X 66" Horseshoe	125	567	
616-DH60	60" X 66" Deep Horseshoe	125	567	
616-BF60	60" Flower	110	473	
616-BC48	48" Clover	85	302	
Laminate Color:			(NO) Natural Oak, (LG) Light Gray, (GC) Grand Cherry, (MA) Maple, (GN) Grey Nebula (MO) Medium Oak (W) Walnut	
			(EC) Extend Color Options - Nearly 200 additional colors, patterns & woodgrains.	
3mm PVC Edgeband Color:			(1) Black T-Moulding - Standard, 3mm Flex PVC Available	
Shipping:			Ships (KD) - Freight code 85	

## Model 631 - Multi-Purpose Art Table

Featuring Corilam's **Sturdy Base** design that incorporates both veneer core and solid wood.  
High pressure laminate top with optional edge designs.  
Heavy duty floor levelers are standard.

Description	Model Number	Table Dimensions D" x W" x H"	Ship Wt	List Price
-------------	--------------	----------------------------------	---------	------------



### Maple Base Art Tables

631D260	42" X 60" X 30"	145	976
631D272	42" X 72" X 30"	161	1096
631D860	48" X 60" X 30"	157	1019
631D872	48" X 72" X 30"	175	1145

**High Pressure Laminate Top:**  
Traditional Post-Formed "Roll Edge" is Standard

### Options (Please Specify When Ordering)

Top Choices:	Standard Laminate Chemsurf Laminate Durasurf™ Epoxy Powder Coated MDF
Front Edge:	(R) Traditional Roll Edge (3) 3mm PVC Edge—1/8" round-over (D) Durasurf™ Epoxy Powder Coated MDF—1/2" radius edges & 1.5" radius corners
Laminate Color:	(NO) Natural Oak, (MO) Medium Oak, (LG) Light Gray, (GC) Grand Cherry, (MA) Maple, (GN) Grey Nebula, (BG) Beige Granite, (ES) Ebony Sand  (EC) Extend Color Options - Nearly 200 additional colors, patterns & woodgrains.
3mm PVC Edgeband Color:	<b>(1) Black - Standard</b> , (3) Light Gray, (M) Matching Woodgrain
Shipping:	<b>Ships (KD) - Freight code 85</b>

### Accessories ( See Accessories Section for Additional Information)

This page is intentionally blank.

### Model 810—Laminated Bookcases

- Featuring 3/4" laminated panels with decorative surface two sides and 3mm PVC edgeband on all exposed edges.
- Sides are bored with 1/4" holes on 1-1/4" centers for adjustability.
- Adjustable shelves are 1" laminated panels with decorative surface two sides and a 3mm PVC front edge.
- Includes clear, thermoplastic shelf pins with double tip inserts and pin clips to secure shelves firmly in place.
- Pin rated at 300 lb capacity. Units ship assembled.



**For widths over 36":**

- Will have one (1) fixed shelf included in design to increase stability
- Will have holes for additional shelf clip in back, with clip included, for extra support

**Shipping:**

Ships (A) Assembled—Freight Code: 125

Model Number	Dimensions (D" x W" x H")	Shelving		Laminated Bookcases		
		Fixed	Adjust	Cubic Ft	Ship Wt	List Price
81023636	12" X 36" x 36"	-	1	3	75	477
81023648	12" X 36" x 48"	-	2	3.5	80	596
81023660	12" X 36" x 60"	1	2	4	85	664
81023672	12" X 36" x 72"	1	3	5	100	770
81023684	12" X 36" x 84"	1	4	6	115	907
Custom	Custom				Call for pricing	Call for pricing
<b>Additional Shelving</b>						
810AS236	11" X 36" x 1"	-	1		19	45

**Options (Please Specify When Ordering)**

**Laminate and Trim Colors**

	Laminate	Black Trim	Light Gray Trim	Matching Wood-grain
<b>(EC) Extended Color Options:</b> Available at no additional charge with a minimum order of twelve (12) units.	<i>Natural Oak</i>	NO1	-	NOM*
	<i>Medium Oak</i>	MO1	-	MOM*
	<i>Maple</i>	MA1	MA3	MAM*
	<i>Grand Cherry</i>	GC1	-	MAM*
	<i>Light Gray</i>	LG1	LG3*	-
*Unless otherwise specified, the default laminate/banding combinations are shown in <b>Bold Italic</b> .	<i>Grey Nebula</i>	GN1*	GN3	-
	<i>Beige Granite</i>	BG1*	-	-
	<i>Ebony Sand</i>	ES1*	-	-
<b>(EC) Extended Color Option:</b> Over 200 laminates to choose from.	<i>Extended Color</i>	EC1*	-	-



### Model 812 - Mobile Laminated Bookcases

- Featuring 3/4" laminated panels with decorative surface two sides and 3mm PVC edgeband on all exposed edges.
- Sides are bored with 1/4" holes on 1-1/4" centers for adjustability.
- Adjustable shelves are 1" laminated panels with decorative surface two sides and a 3mm PVC front edge.
- Includes clear, thermoplastic shelf pins with double tip inserts and pin clips to secure shelves firmly in place.
- Pin rated at 300 lb capacity. Units ship assembled.



For widths over 36":

- Will have one (1) fixed shelf included in design to increase stability
- Will have holes for additional shelf clip in back, with clip included, for extra support

Shipping:

Ships (A) Assembled—Freight Code: 125

Model Number	Dimensions (D" x W" x H")	Shelving		Laminated Bookcases		
		Fixed	Adjust	Cubic Ft	Ship Wt	List Price
81223636	18" X 36" x 36"	-	1	3	75	1275
81223660	18" X 36" x 42"	-	2	4	85	1465
Custom	Custom				Call for pricing	Call for pricing
<b>Additional Shelving</b>						
810AS836	17" X 36" x 1"	-	1		19	32
<b>Options (Please Specify When Ordering)</b>		<b>Laminate and Trim Colors</b>				
		<b>Laminate</b>	<b>Black Trim</b>	<b>Light Gray Trim</b>	<b>Matching Wood-grain</b>	
<b>(EC) Extended Color Options:</b> Available at no additional charge with a minimum order of twelve (12) units.		<i>Natural Oak</i>	<i>NO1</i>	-	<i>NOM*</i>	
		<i>Medium Oak</i>	<i>MO1</i>	-	<i>MOM*</i>	
		<i>Maple</i>	<i>MA1</i>	<i>MA3</i>	<i>MAM*</i>	
*Unless otherwise specified, the default laminate/banding combinations are shown in <b>Bold Italic</b> .		<i>Grand Cherry</i>	<i>GC1</i>	-	<i>MAM*</i>	
		<i>Light Gray</i>	<i>LG1</i>	<b>LG3*</b>	-	
		<i>Grey Nebula</i>	<b>GN1*</b>	<i>GN3</i>	-	
<b>(EC) Extended Color Option:</b> Over 200 laminates to choose from.		<i>Beige Granite</i>	<b>BG1*</b>	-	-	
		<i>Ebony Sand</i>	<b>ES1*</b>	-	-	
		<i>Extended Color</i>	<b>EC1*</b>	-	-	

## Music Instrument Storage

Featuring Corilam's contoured, **Kydex** thermoplastic alloy shelving. Sides, back, bottom, and top are 3/4" thermofused melamine. All units except 60" wide are shipped fully assembled (A). Full HPL laminated cabinets are available.

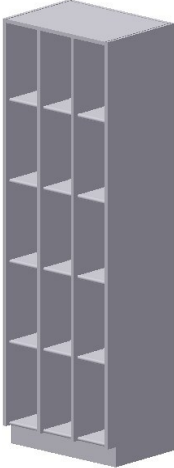
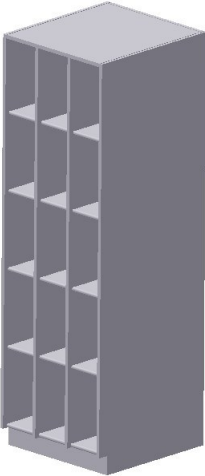
Description	Model Number	Doors	Ship Wt	List Price
 <p>Cabinet - #01 15 Compartments 8" x 16" x 18" Openings Stores 15 Clarinets, Flutes, Piccolos or Oboes</p>	<b>Cabinet - 01 (D)19 1/4" x (W) 27" x (H) 85 5/8"</b>			
	441-0100	No Doors	285	2386
	441-0110	Full Laminate Doors	333	2719
	441-0120	Full Wire Doors w/ Hasp	310	2866
	441-0130	Full Wire Doors w/ Latch	310	2904
	441-0140	Compartment Laminate Doors	333	3578
	441-0150	Compartment Grill Doors w/ Hasp	333	3749
	441-0160	Compartment Grill Doors w/ Latch	333	4530
 <p>Cabinet - #02 15 Compartments 8" x 16" x 28" Openings Stores 15 Clarinets, Flutes, Piccolos or Oboes</p>	<b>Cabinet - 02 (D)29 1/4" x (W) 27" x (H) 85 5/8"</b>			
	442-0200	No Doors	435	2757
	442-0210	Full Laminate Doors	483	3088
	442-0220	Full Wire Doors w/ Hasp	463	3255
	442-0230	Full Wire Doors w/ Latch	463	3293
	442-0240	Compartment Laminate Doors	496	3949
	442-0250	Compartment Grill Doors w/ Hasp	483	4921
	442-0260	Compartment Grill Doors w/ Latch	483	5443
<b>Options</b> (Please Specify When Ordering)				
Laminate Color:	(NO) Natural Oak, (LG) Light Gray, (GC) Grand Cherry, (MA) Maple, (GN) Grey Nebula			
	(EC) Extended Color Options - Call for Quotation			
3MM PVC Edgeband Color:	(1) Black, (3) Light Gray, (M) Matching Woodgrain			
Shelf Color:	(SG) Gray Only			
Hardware Color (Wire Doors, Label Holder, Hasp, Hinge) :	(H1) Black, (H2) Beige, (H3) Gray, (H4) Chrome			

## Music Instrument Storage

Description	Model Number	Doors	Ship Wt	List Price
-------------	--------------	-------	---------	------------

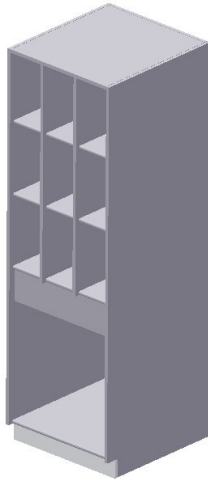

Cabinet - #03  
9 Compartments  
8" x 16" x 28" Openings  
Stores 9 Clarinets, Flutes, Piccolos or Oboes  
1 Compartment  
29" x 25" Opening  
Stores 1 French Horn, Alto Horn, or Snare Drum

### Cabinet - 03 (D)29 1/4 " x (W) 27" x (H) 85 5/8"

442-0300	No Doors	363	2321
442-0310	Full Laminate Doors	483	2650
442-0320	Full Wire Doors w/ Hasp	463	2797
442-0330	Full Wire Doors w/ Latch	463	2836
442-0340	Compartment Laminate Doors	496	3168
442-0350	Compartment Grill Doors w/ Hasp	483	4392
442-0360	Compartment Grill Doors w/ Latch	483	4802

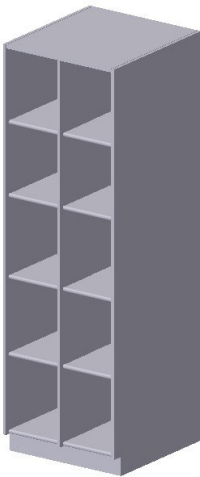

Cabinet - #04  
10 Compartments  
12" x 16" Openings  
Stores 10 Trumpets, Coronets, or Alto Saxophones

### Cabinet - 04 (D)29 1/4 " x (W) 27" x (H) 85 5/8"

442-0400	No Doors	395	2367
442-0410	Full Laminate Doors	445	2699
442-0420	Full Wire Doors w/ Hasp	420	2848
442-0430	Full Wire Doors w/ Latch	420	2887
442-0440	Compartment Laminate Doors	455	3205
442-0450	Compartment Grill Doors w/ Hasp	445	4018
442-0460	Compartment Grill Doors w/ Latch	445	4409

### Options (Please Specify When Ordering)

Laminate Color:	(NO) Natural Oak, (LG) Light Gray, (GC) Grand Cherry, (MA) Maple, (GN) Grey Nebula (EC) Extended Color Options - Call for Quotation
3MM PVC Edgeband Color:	(1) Black, (3) Light Gray, (M) Matching Woodgrain
Shelf Color:	(SG) Gray Only
Hardware Color (Wire Doors, Label Holder, Hasp, Hinge) :	(H1) Black, (H2) Beige, (H3) Gray, (H4) Chrome

## Music Instrument Storage

Description	Model Number	Doors	Ship Wt	List Price
-------------	--------------	-------	---------	------------

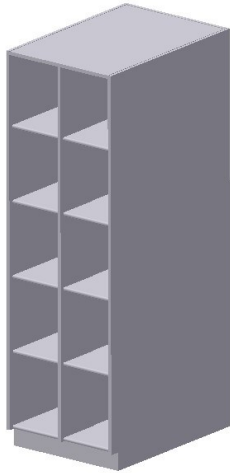

Cabinet - #05  
10 Compartments  
12" x 16" Openings  
Stores 10 Trombones, Bassoons, Bass Clarinets, Violins, Violas, Tenor Sax, or Alto Clarinets

### Cabinet - 05 (D)39 1/4" x (W) 27" x (H) 85 5/8"

443-0500	No Doors	395	2673
443-0510	Full Laminate Doors	445	3003
443-0520	Full Wire Doors w/ Hasp	420	3167
443-0530	Full Wire Doors w/ Latch	420	3206
443-0540	Compartment Laminate Doors	455	3504
443-0550	Compartment Grill Doors w/ Hasp	445	4332
443-0560	Compartment Grill Doors w/ Latch	445	4725

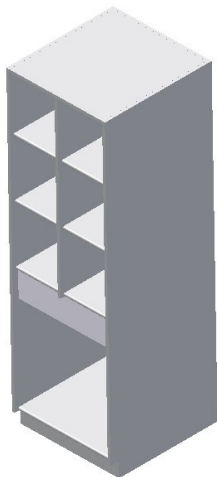

Cabinet - #06  
6 Compartments  
12" x 14" Openings  
Stores 6 Trumpets, Corinets, or Alto Saxophones  
  
1 Compartment  
25" x 25" Openings  
Stores 1 Alto Horn or Snare Drum

### Cabinet - 06 (D)29 1/4" x (W) 27" x (H) 85 5/8"

442-0600	No Doors	330	2099
442-0610	Full Laminate Doors	380	2429
442-0620	Full Wire Doors w/ Hasp	355	2569
442-0630	Full Wire Doors w/ Latch	355	2607
442-0640	Compartment Laminate Doors	390	2729
442-0650	Compartment Grill Doors w/ Hasp	380	3324
442-0660	Compartment Grill Doors w/ Latch	380	3601

### Options (Please Specify When Ordering)

Laminate Color:	(NO) Natural Oak, (LG) Light Gray, (GC) Grand Cherry, (MA) Maple, (GN) Grey Nebula
	(EC) Extended Color Options - Call for Quotation
3MM PVC Edgeband Color:	(1) Black, (3) Light Gray, (M) Matching Woodgrain
Shelf Color:	(SG) Gray Only
Hardware Color (Wire Doors, Label Holder, Hasp, Hinge) :	(H1) Black, (H2) Beige, (H3) Gray, (H4) Chrome

## Music Instrument Storage

Description	Model Number	Doors	Ship Wt	List Price
-------------	--------------	-------	---------	------------

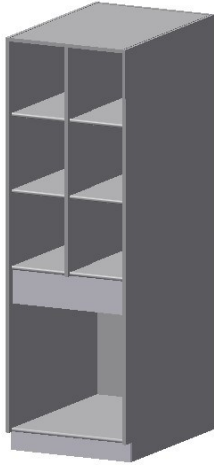

Cabinet - #07  
6 Compartments  
12" x 14" Openings  
Stores 6 Trombones, Bassoons, Bass Clarinets, Violins, Violas, Tenor Sax, or Alto Clarinets  
1 Compartment  
25" x 25" Openings  
Stores 1 Baritone Horn, Euphonium, or Mellophone

### Cabinet - 07 (D)39 1/4" x (W) 27" x (H) 85 5/8"

443-0700	No Doors	390	2351
443-0710	Full Laminate Doors	440	2678
443-0720	Full Wire Doors w/ Hasp	415	2822
443-0730	Full Wire Doors w/ Latch	415	2862
443-0740	Compartment Laminate Doors	450	2983
443-0750	Compartment Grill Doors w/ Hasp	440	3588
443-0760	Compartment Grill Doors w/ Latch	440	3864



Cabinet - #08  
1 Compartment  
25" x 78" Openings  
Stores 1 String Bass, Contra Bass Clarinet, or Bass Drum

### Cabinet - 08 (D)29 1/4" x (W) 27" x (H) 85 5/8"

442-0800	No Doors	222	1369
442-0810	Full Laminate Doors	275	1702
442-0820	Full Wire Doors w/ Hasp	250	1820
442-0830	Full Wire Doors w/ Latch	250	1858

### Options (Please Specify When Ordering)

Laminate Color:	(NO) Natural Oak, (LG) Light Gray, (GC) Grand Cherry, (MA) Maple, (GN) Grey Nebula (EC) Extended Color Options - Call for Quotation
3MM PVC Edgeband Color:	(1) Black, (3) Light Gray, (M) Matching Woodgrain
Shelf Color:	(SG) Gray Only
Hardware Color (Wire Doors, Label Holder, Hasp, Hinge) :	(H1) Black, (H2) Beige, (H3) Gray, (H4) Chrome

## Music Instrument Storage

Description	Model Number	Doors	Ship Wt	List Price
-------------	--------------	-------	---------	------------



Cabinet - #09  
1 Compartment  
25" x 61" Opening  
Stores 1 Cello or Guitar  
and 1 Snare Drum  
  
1 Compartment  
25" x 14" Opening  
For General Storage

### Cabinet - 09 (D)29 1/4 " x (W) 27" x (H) 85 5/8"

442-0900	No Doors	249	1457
442-0910	Full Laminate Doors	300	1791
442-0920	Full Wire Doors w/ Hasp	275	1893
442-0930	Full Wire Doors w/ Latch	275	1932

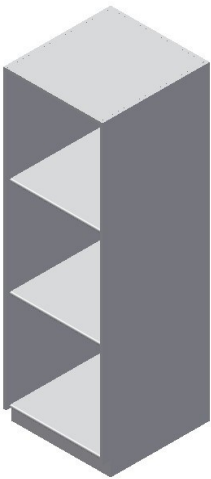

Cabinet - #10  
3 Compartments  
27" x 25" Openings  
Stores 3 French Horns,  
Alto Horns, or Snare  
Drums



### Cabinet - 10 (D)29 1/4 " x (W) 27" x (H) 85 5/8"

442-1000	No Doors	276	1614
442-1010	Full Laminate Doors	327	1945
442-1020	Full Wire Doors w/ Hasp	305	2061
442-1030	Full Wire Doors w/ Latch	305	2100
442-1040	Compartment Laminate Doors	340	2099
442-1050	Compartment Grill Doors w/ Hasp	326	2360
442-1060	Compartment Grill Doors w/ Latch	326	2479

### Options (Please Specify When Ordering)

Laminate Color: (NO) Natural Oak, (LG) Light Gray, (GC) Grand Cherry, (MA) Maple, (GN) Grey Nebula  
(EC) Extended Color Options - Call for Quotation  
3MM PVC Edgeband Color: (1) Black, (3) Light Gray, (M) Matching Woodgrain  
Shelf Color: (SG) Gray Only  
Hardware Color (Wire Doors, Label Holder, Hasp, Hinge) : (H1) Black, (H2) Beige, (H3) Gray, (H4) Chrome

## Music Instrument Storage

Description	Model Number	Doors	Ship Wt	List Price
 <p>Cabinet - #11 3 Compartments 27" x 25" Openings Stores 3 Baritones, Euphoniums, or Mellophones</p>	<b>Cabinet - 11 (D)39 1/4" x (W) 27" x (H) 85 5/8"</b>			
	443-1100	No Doors	333	1777
	443-1110	Full Laminate Doors	383	2111
	443-1120	Full Wire Doors w/ Hasp	358	2246
	443-1130	Full Wire Doors w/ Latch	358	2285
	443-1140	Compartment Laminate Doors	400	2191
	443-1150	Compartment Grill Doors w/ Hasp	385	2478
	443-1160	Compartment Grill Doors w/ Latch	385	2596
 <p>Cabinet - #12 3 Compartments 46" x 25" Openings Stores 3 Baritone Saxophones, Bass Clarinets, Bassoons, Field Drums, or Snare Drums.</p>	<b>Cabinet - 12 (D)29 1/4" x (W) 48" x (H) 85 5/8"</b>			
	445-1200	No Doors	372	2020
	445-1210	Full Laminate Doors	456	2496
	445-1220	Full Wire Doors w/ Hasp	444	2747
 <p>Cabinet - #13 5 Compartments 12" x 14" Openings Stores 5 Trumpets, Cornets, or Alto Saxophones.</p>	<b>Cabinet - 13 (D)29 1/4" x (W) 14" x (H) 85 5/8"</b>			
	446-1300	No Doors	245	1466
	446-1310	Full Laminate Doors	276	1674
	446-1340	Compartment Laminate Doors	282	1985
	446-1350	Compartment Grill Doors w/ Hasp	276	2491
	446-1360	Compartment Grill Doors w/ Latch	276	2731
<b>Options</b> (Please Specify When Ordering)				
Laminate Color:	(NO) Natural Oak, (LG) Light Gray, (GC) Grand Cherry, (MA) Maple, (GN) Grey Nebula			
	(EC) Extended Color Options - Call for Quotation			
3MM PVC Edgeband Color:	(1) Black, (3) Light Gray, (M) Matching Woodgrain			
Shelf Color:	(SG) Gray Only			
Hardware Color (Wire Doors, Label Holder, Hasp, Hinge):	(H1) Black, (H2) Beige, (H3) Gray, (H4) Chrome			

## Music Instrument Storage

Description	Model Number	Doors	Ship Wt	List Price
-------------	--------------	-------	---------	------------

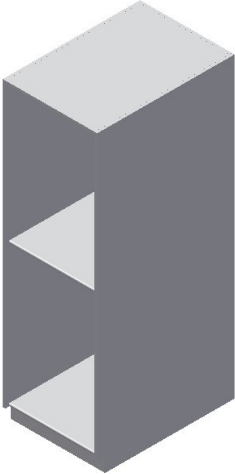
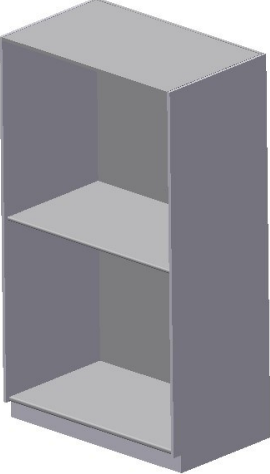
 <p>Cabinet - #14 2 Compartments 27" x 37" Openings Stores 2 Bass Drums, Field Drums, Snare Drums, or Parade Drums</p>	<b>Cabinet - 14 (D)39 1/4" x (W) 27" x (H) 85 5/8"</b>			
	443-1400	No Doors	300	1705
	443-1410	Full Laminate Doors	350	2041
	443-1420	Full Wire Doors w/ Hasp	330	2176
	443-1430	Full Wire Doors w/ Latch	330	2216
 <p>Cabinet - #15 2 Compartments 46" x 38" Openings Stores 2 Bass Drums, Field Drums, Snare Drums, Parade Drums, Tri Toms, Quads, Tubas, or Sousaphones</p>	<b>Cabinet - 15 (D)29 1/4" x (W) 48" x (H) 85 5/8"</b>			
	445-1500	No Doors	327	1880
	445-1510	Full Laminate Doors	420	2281
	445-1520	Full Wire Doors w/ Hasp	395	3119



### Options (Please Specify When Ordering)

Laminate Color:	(NO) Natural Oak, (LG) Light Gray, (GC) Grand Cherry, (MA) Maple, (GN) Grey Nebula
	(EC) Extended Color Options - Call for Quotation
3MM PVC Edgeband Color:	(1) Black, (3) Light Gray, (M) Matching Woodgrain
Shelf Color:	(SG) Gray Only
Hardware Color (Wire Doors, Label Holder, Hasp, Hinge) :	(H1) Black, (H2) Beige, (H3) Gray, (H4) Chrome

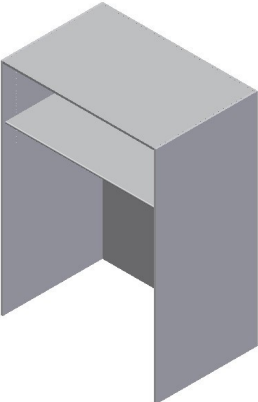

## Music Instrument Storage

Description	Model Number	Doors	Ship Wt	List Price
-------------	--------------	-------	---------	------------



 <p>Cabinet - #17 1 Compartment Compartment includes 1 adjustable shelf. Adjustment from 46" to 60" off the floor.</p>	<p><b>Cabinet - 17 (D)39 1/4 " x (W) 60" x (H) 85 5/8"</b></p> <table border="1" style="width: 100%; border-collapse: collapse;"> <tbody> <tr> <td style="width: 20%;">443-1700</td> <td style="width: 40%;">No Doors</td> <td style="width: 20%;">395</td> <td style="width: 20%;">2146</td> </tr> <tr> <td>443-1710</td> <td>Full Laminate Doors</td> <td>502</td> <td>2764</td> </tr> </tbody> </table>	443-1700	No Doors	395	2146	443-1710	Full Laminate Doors	502	2764																				
443-1700	No Doors	395	2146																										
443-1710	Full Laminate Doors	502	2764																										
 <p>Cabinet - #19 6 Compartments 8" x 38" Openings Stores 6 Acoustic Guitars</p>	<p><b>Cabinet - 19 (D)39 1/4 " x (W) 27" x (H) 85 5/8"</b></p> <table border="1" style="width: 100%; border-collapse: collapse;"> <tbody> <tr> <td style="width: 20%;">443-1900</td> <td style="width: 40%;">No Doors</td> <td style="width: 20%;">463</td> <td style="width: 20%;">2209</td> </tr> <tr> <td>443-1910</td> <td>Full Laminate Doors</td> <td>520</td> <td>2542</td> </tr> <tr> <td>443-1920</td> <td>Full Wire Doors w/ Hasp</td> <td>495</td> <td>2692</td> </tr> <tr> <td>443-1930</td> <td>Full Wire Doors w/ Latch</td> <td>495</td> <td>2730</td> </tr> <tr> <td>443-1940</td> <td>Compartment Laminate Doors</td> <td>540</td> <td>4351</td> </tr> <tr> <td>443-1950</td> <td>Compartment Grill Doors w/ Hasp</td> <td>490</td> <td>4560</td> </tr> <tr> <td>443-1960</td> <td>Compartment Grill Doors w/ Latch</td> <td>490</td> <td>4796</td> </tr> </tbody> </table>	443-1900	No Doors	463	2209	443-1910	Full Laminate Doors	520	2542	443-1920	Full Wire Doors w/ Hasp	495	2692	443-1930	Full Wire Doors w/ Latch	495	2730	443-1940	Compartment Laminate Doors	540	4351	443-1950	Compartment Grill Doors w/ Hasp	490	4560	443-1960	Compartment Grill Doors w/ Latch	490	4796
443-1900	No Doors	463	2209																										
443-1910	Full Laminate Doors	520	2542																										
443-1920	Full Wire Doors w/ Hasp	495	2692																										
443-1930	Full Wire Doors w/ Latch	495	2730																										
443-1940	Compartment Laminate Doors	540	4351																										
443-1950	Compartment Grill Doors w/ Hasp	490	4560																										
443-1960	Compartment Grill Doors w/ Latch	490	4796																										

**Options** (Please Specify When Ordering)

Laminate Color:	(NO) Natural Oak, (LG) Light Gray, (GC) Grand Cherry, (MA) Maple, (GN) Grey Nebula
	(EC) Extended Color Options - Call for Quotation
3MM PVC Edgeband Color:	(1) Black, (3) Light Gray, (M) Matching Woodgrain
Shelf Color:	(SG) Gray Only
Hardware Color (Wire Doors, Label Holder, Hasp, Hinge) :	(H1) Black, (H2) Beige, (H3) Gray, (H4) Chrome

## Robe and Uniform Storage

Description	Model Number	Doors	Ship Wt	List Price
-------------	--------------	-------	---------	------------

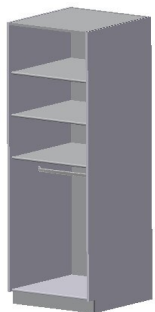
 <p>2 Hanging Rods Stores 24 robes or uniforms</p>	<b>Uniform Storage - (D) 29 1/4 " x (W) 27" x (H) 85 5/8"</b>				
		442-2400	No Doors	256	1477
		442-2410	Full Laminate Doors	281	1810
		442-2420	Full Wire Doors with Hasp	293	1931
 <p>1 Hanging Rod Stores 12 robes or uniforms</p>	<b>Robe &amp; Uniform Storage - (D) 29 1/4 " x (W) 27" x (H) 85 5/8"</b>				
		442-2500	No Doors	253	1421
		442-2510	Full Laminate Doors	278	1757
		442-2520	Full Wire Doors with Hasp	290	1880
 <p>3 Shelves 1 Hanging Rod Stores 12 robes or uniforms and 12 Hats</p>	<b>Uniform &amp; Hat Storage - (D) 29 1/4 " x (W) 27" x (H) 85 5/8"</b>				
		442-2600	No Doors	314	1779
		442-2610	Full Laminate Doors	339	2115
		442-2620	Full Wire Doors with Hasp	351	2253

**Options** (Please Specify When Ordering)

Laminate Color:	(NO) Natural Oak, (LG) Light Gray, (GC) Grand Cherry, (MA) Maple, (GN) Grey Nebula
	(EC) Extended Color Options - Call for Quotation
3MM PVC Edgeband Color:	(1) Black, (3) Light Gray, (M) Matching Woodgrain
Shelf Color:	(SG) Gray Only

## Robe and Uniform Storage

Description	Model Number	Doors	Ship Wt	List Price
-------------	--------------	-------	---------	------------

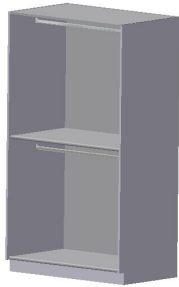

2 Hanging Rods  
Stores 40 robes or uniforms

**Uniform Storage - (D) 29 1/4" x (W) 48" x (H) 85 5/8"**

445-2700	No Doors	327	1575
445-2710	Full Laminate Doors	368	1907
445-2720	Full Wire Doors with Hasp	381	2799



1 Hanging Rod  
Stores 20 robes or uniforms

**Robe & Uniform Storage - (D) 29 1/4" x (W) 48" x (H) 85 5/8"**

445-2800	No Doors	321	1547
445-2810	Full Laminate Doors	362	1880
445-2820	Full Wire Doors with Hasp	375	2731

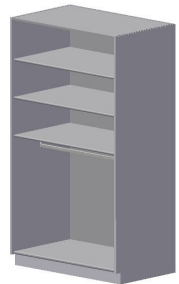

3 Shelves  
1 Hanging Rod  
Stores 20 robes or uniforms and 24 Hats

**Uniform & Hat Storage - (D) 29 1/4" x (W) 48" x (H) 85 5/8"**

445-2900	No Doors	422	2229
445-2910	Full Laminate Doors	463	2628
445-2920	Full Wire Doors with Hasp	477	3394

**Options** (Please Specify When Ordering)

Laminate Color: (NO) Natural Oak, (LG) Light Gray, (GC) Grand Cherry, (MA) Maple, (GN) Grey Nebula

(EC) Extended Color Options - Call for Quotation

3MM PVC Edgeband Color: (1) Black, (3) Light Gray, (M) Matching Woodgrain

Shelf Color: (SG) Gray Only

## Music Folio Storage

Slotted music storage with adjustable height slots that accommodate different thickness music folios and sheet music. All units are shipped assembled.

Description	Model Number	Doors	Ship Wt	List Price
-------------	--------------	-------	---------	------------

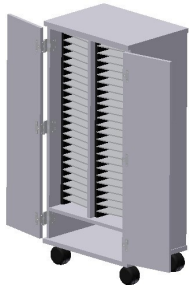
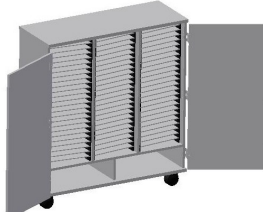
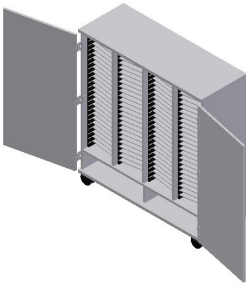
 <p>50 Slots for Folio Storage 1 Bottom shelf for general storage</p>	<b>Folio 50 - (D) 18" x (W) 24" x (H) 50"</b>			
	444-2100	No Doors	175	1541
	444-2110	Full Laminate Doors	188	1739
 <p>75 Slots for Folio Storage Divided bottom shelf for general storage</p>	<b>Folio 75 - (D) 18" x (W) 48" x (H) 50"</b>			
	444-2200	No Doors	300	2206
	444-2210	Full Laminate Doors	375	2419
 <p>100 Slots for Folio Storage Divided bottom shelf for general storage</p>	<b>Folio 100 - (D) 18" x (W) 48" x (H) 50"</b>			
	444-2300	No Doors	320	2941
	444-2310	Full Laminate Doors	375	3297

### Options (Please Specify When Ordering)

Laminate Color:	(NO) Natural Oak, (LG) Light Gray, (GC) Grand Cherry, (MA) Maple, (GN) Grey Nebula
	(EC) Extended Color Options - Call for Quotation
3MM PVC Edgeband Color:	(1) Black, (3) Light Gray, (M) Matching Woodgrain
Shelf Color:	(SG) Gray Only
Door Locks:	(L) Door Locks - Add \$40
Casters:	(C) 2 Locking, 2 Non-Locking Casters - Add \$70

## Music Folio Storage

Description	Model Number	Description	Ship Wt	List Price
-------------	--------------	-------------	---------	------------



### Sheet Music Storage System

444-2404	Four Shelf Library Unit	270	3955
444-2406	Six Shelf Library Unit	295	4207
444-2407	Seven Shelf Library Unit	320	4460

### Wall Storage for Sheet Music

Individual units combine for an extensive and versatile library system.



### Instrument Racks

449-1340	4 Unit Cello Rack	53	1555
449-1240	4 Unit Bass Rack	74	1963

### Upright Storage for Stringed Instruments

Mobile units for easy and convenient storage. Spacing allows for multiple sizes. Includes bow hooks.

### Options (Please Specify When Ordering)

Laminate Color:	(NO) Natural Oak, (LG) Light Gray, (GC) Grand Cherry, (MA) Maple, (GN) Grey Nebula
	(EC) Extended Color Options - Call for Quotation
3MM PVC Edgeband Color:	(1) Black, (3) Light Gray, (M) Matching Woodgrain

## Model 740-1032 - 32 Tablet Storage & Charging Cart

Specially designed to store , charge and secure all of your Tablets and similar electronic devices in proper horizontal position



Options (Please contact for pricing)

- Syncing Hub

Model Number	Dimensions (D" x W" x H)	Description	List Price
740-1032	22" X 25.6" X 46"	32 Tablet Cart	2750
550-1410		Optional Tablet Mount	295
<b>Options</b> (Please Specify When Ordering)			
Laminate Color:	(MA) Maple, (SH) Shaker Cherry (GC) Grand Cherry, (GN) Grey Nebula (EC) Extend Color Options - Nearly 200 additional colors, patterns & woodgrains.		
Shipping:	<b>Ships (Assembled) - Freight code 125</b>		

## Model 740-1034 Teacher Storage & Presentation Cart

This mobile storage unit offers the teacher a mobile presentation surface with plenty of storage. The floating top and rounded edges continue the design statement from the Evolutions Series.

There are several grommets located throughout the unit to allow for cord access both internally and externally in order for the unit to be used with most any technology requirement.



### Options:

- Plastic Totes
- 6 outlet power strip
- Optional laminates ( call for pricing )



Model Number	Dimensions (D" x W" x H)	Description	Weight	List Price
740-1034	22" X 25.6" X 46"	Floating Top Teacher Cabinet		1050
550-1410		Optional Tablet Mount		295
<b>Options</b> (Please Specify When Ordering)				
Laminate Color:	(MA) Maple, (SH) Shaker Cherry (GC) Grand Cherry, (GN) Grey Nebula (EC) Extend Color Options - Nearly 200 additional colors, patterns & woodgrains.			
Clear Plastic Tote Trays (EA)	Specify Quantity : 0 –5 (\$60 Each)			
Electrical	(E1) Six Outlet Power Strip (\$60 Each)			
Shipping:	<b>Ships (Assembled) - Freight code 125</b>			

## 710 Series—Steel Frame Mobile Storage Units

Constructed with a *Fully Welded*, unitized frame. Corilam's Mobile Storage Units are available in unlimited configurations. Please request a quotation for additional options and pricing.

### Multi Purpose Storage Cabinet Configurations



Single Sided	710-1200	710-1300	710-2200	710-3210	710-3300
Double Sided	710-1228	710-1328	710-2228	713-3228	710-3328

Model Number	Dimensions	Description	Shelving	Weight	Price
710-1200	25D X 48 W X 72H	TMS Full Width Adjustable Shelf Unit	4 Adjustable	447	2530
710-1300	25D X 48 W X 72H	TMS Divided Adjustable Shelf Unit	8 Adjustable	476	2724
710-2200	25D X 48 W X 36H	LMS Open Face Adjustable Shelf Unit	1 Adjustable	304	1236
710-3210	25D X 48 W X 36H	LMS Adjustable Shelving Unit	1 Adjustable	313	1558
710-3300	25D X 48 W X 36H	LMS Divided Adjustable Shelf Unit	2 Adjustable	329	1680
710-1228	28D X 48 W X 72H	TMS Full Width Adjustable Shelf Double Sided Unit	4 Adjustable/Side	510	3923
710-1328	28D X 48 W X 72H	TMS Divided Adjustable Shelf Double Sided Unit	8 Adjustable/Side	543	4225
710-2228	28D X 48 W X 36H	LMS Open Face Adjustable Shelf Double Sided Unit	1 Adjustable/Side	350	1914
710-3228	28D X 48 W X 36H	LMS Adjustable Shelving Double Sided Unit	1 Adjustable/Side	360	2416
710-3328	28D X 48 W X 36H	LMS Divided Adjustable Shelf Double Sided Unit	2 Adjustable/Side	378	2603

### Teacher Storage / Wardrobe Cabinet Configurations



710-1310                      710-1320                      710-1500                      710-1528

Model Number	Dimensions	Description	Shelving	Weight	Price
710-1310	25D X 48 W X 72H	TMS Teacher / Wardrobe Cabinet	4 Adjustable	453	2607
710-1320	25D X 48 W X 72H	TMS Teacher / Wardrobe Cabinet w/ File Cabinet	2 Adjustable	493	3462
710-1500	25D X 48 W X 72H	TMS Student Wardrobe Cabinet	1 Fixed	408	2653
710-1528	28D X 48 W X 72H	TMS Student Wardrobe Double Sided Unit	1 Fixed	457	4113



## 710 Series—Steel Frame Mobile Storage Units

Constructed with a **Fully Welded**, unitized frame. Corilam's Mobile Storage Units are available in unlimited configurations. Please request a quotation for additional options and pricing.

### Tray Tote Storage Cabinet Configurations



Single Sided	710-1100	710-1400	710-2400	710-3100
Double Sided	710-1128	710-1428	710-2428	710-3128

Model Number	Dimensions	Description	Shelving	Weight	Price
710-1100	25D X 48 W X 72H	TMS Full Width Fixed Shelf Unit	7 Fixed	486	2653
710-1400	25D X 48 W X 72H	TMS Open Fixed Shelf Unit	7 Fixed	422	1729
710-2400	25D X 48 W X 36H	LMS Open Face Fixed Shelf Unit	4 Fixed	330	1408
710-3100	25D X 48 W X 36H	LMS Fixed Shelf Unit	4 Fixed	352	1590
710-1128	28D X 48 W X 72H	TMS Full Width Fixed Shelf Double Sided Unit	7 Fixed/Side	544	4113
710-1428	28D X 48 W X 72H	TMS Open Fixed Shelf Double Sided Unit	7 Fixed/Side	473	2678
710-2428	28D X 48 W X 36H	LMS Open Face Fixed Shelf Double Sided Unit	4 Fixed/Side	370	1742
710-3128	28D X 48 W X 36H	LMS Fixed Shelf Double Sided Unit	4 Fixed/Side	394	2468

*Tote Trays Not Included. See Accessories, Page 54 for Additional Information.*

### Paper Storage Cabinet Configurations



710-2500

Model Number	Dimensions	Description	Shelving	Weight	Price
710-2500	28D X 48 W X 36H	LMS 5-Drawer Paper Storage	N/A	384	2528

Options & Accessories:  
(Please Specify When Ordering)

Laminate Color:	(NO) Natural Oak, (LG) Light Gray, (GC) Grand Cherry, (MA) Maple, (GN) Grey Nebula (EC) Extend Color Options - Nearly 100 additional colors, patterns & woodgrains.
3mm PVC Edgeband Color:	<b>(1) Black - Standard</b> , (3) Light Gray, (M) Matching Woodgrain
Locks:	(L) Locking Option - Add \$60 List Price Per Cabinet

## 730 Series - All Panel Construction Mobile Storage Units

Integrated panels with a unique, tamper proof, steel fastening system. Corilam's Mobile Storage Units are available in unlimited configurations. Please request a quotation for additional options and pricing.

### Multi Purpose Storage Cabinet Configurations



Single Sided	730-1200	730-1300	730-2200	730-3210	730-3300
Double Sided	730-1228	730-1328	730-2228	730-3228	730-3328

Model Number	Dimensions	Description	Shelving	Weight	Price
730-1200	24D X 48 W X 68H	TPC Full Width Adjustable Shelf Unit	4 Adjustable	402	2129
730-1300	24D X 48 W X 68H	TPC Divided Adjustable Shelf Unit	8 Adjustable	428	2324
730-2200	24D X 48 W X 36H	LPC Open Face Adjustable Shelf Unit	1 Adjustable	246	995
730-3210	24D X 48 W X 36H	LPC Adjustable Shelving Unit	1 Adjustable	252	1317
730-3300	24D X 48 W X 36H	LPC Divided Adjustable Shelf Unit	2 Adjustable	264	1439
730-1228	28D X 48 W X 68H	TPC Full Width Adjustable Shelf Double Sided Unit	4 Adjustable/Side	469	3521
730-1328	28D X 48 W X 68H	TPC Divided Adjustable Shelf Double Sided Unit	8 Adjustable/Side	499	3825
730-2228	28D X 48 W X 36H	TPC Open Face Adjustable Shelf Double Sided Unit	1 Adjustable/Side	287	1674
730-3228	28D X 48 W X 36H	LPC Adjustable Shelving Double Sided Unit	1 Adjustable/Side	294	2176
730-3328	28D X 48 W X 36H	LPC Divided Adjustable Shelf Double Sided Unit	2 Adjustable/Side	308	2363

### Teacher Storage / Wardrobe Cabinet Configurations



730-1310                      730-1320                      730-2610

Model Number	Dimensions	Description	Shelving	Weight	Price
730-1310	24D X 48 W X 68H	TMS Teacher / Wardrobe Cabinet	4 Adjustable	430	2206
730-1320	24D X 48 W X 68H	TMS Teacher / Wardrobe Cabinet w/ File Cabinet	2 Adjustable	470	3062
730-2608	32D X 37 W X 56H	All Panel 8 Student Cubbie / Coat Storage	N/A	427	2253
730-2612	32D X 56 W X 56H	All Panel 12 Student Cubbie / Coat Storage	N/A	576	3713

## 730 Series - All Panel Construction Mobile Storage Units

Integrated panels with a unique, tamper proof, steel fastening system.  
Corilam's Mobile Storage Units are available in unlimited configurations.  
**Please request a quotation for additional options and pricing.**

### Tray Tote Storage Cabinet Configurations



Single Sided	730-1100	730-1400	730-2400	730-3100
Double Sided	730-1128	730-1428	730-2428	730-3128

Model Number	Dimensions	Description	Shelving	Weight	Price
730-1100	24D X 48 W X 68H	TPC Full Width Fixed Shelf Unit	7 Fixed	441	2253
730-1400	24D X 48 W X 68H	TPC Open Fixed Shelf Unit	7 Fixed	377	1329
730-2400	24D X 48 W X 36H	LPC Open Face Fixed Shelf Unit	4 Fixed	285	1168
730-3100	24D X 48 W X 36H	LPC Fixed Shelf Unit	4 Fixed	291	1351
730-1128	28D X 48 W X 68H	TPC Full Width Fixed Shelf Double Sided Unit	7 Fixed/Side	514	3713
730-1428	28D X 48 W X 68H	TPC Open Fixed Shelf Double Sided Unit	7 Fixed/Side	440	2278
730-2428	28D X 48 W X 36H	LPC Open Face Fixed Shelf Double Sided Unit	4 Fixed/Side	333	1502
730-3128	28D X 48 W X 36H	LPC Fixed Shelf Double Sided Unit	4 Fixed/Side	340	2227

*Tote Trays Not Included. See Accessories, Page 54 for Additional Information.*

### Paper Storage Cabinet Configurations



730-2500                      730-2510                      730-1230

Model Number	Dimensions	Description	Shelving	Weight	Price
730-2500	28D X 48 W X 36H	LPC 5-Drawer Paper Storage	N/A	326	2289
730-2510	28D X 48 W X 36H	LPC Paper Storage with Adjustable Shelving	1 Adjustable	315	1844
730-1230	28D X 48 W X 68H	TPC Adjustable Shelving w/ paper storage	2 Adjustable	480	3038

**Options & Accessories:**  
(Please Specify When Ordering)

Laminate Color: (NO) Natural Oak, (LG) Light Gray, (GC) Grand Cherry, (MA) Maple, (GN) Grey Nebula  
(EC) Extend Color Options - Nearly 100 additional colors, patterns & woodgrains.

3mm PVC Edgeband Color: **(1) Black - Standard**, (3) Light Gray, (M) Matching Woodgrain

Locks: (L) Locking Option - Add \$60 List Price Per Cabinet

## 710 & 730 Series - Mobile Storage Units Accessories

### Tray Tote Storage

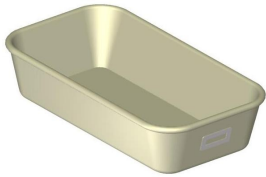

Model Number	Dimensions	Description	Color	Weight	Price
794-1909	19 x 9 x 4 3/8	Fits (5) per shelf in Standard 48" Wide Unit	Tan	1	24
794-1910	19 x 10 1/2 x 4 3/8	Fits (4) per shelf in Standard 48" Wide Unit	Tan	1	24
794-1913	19 x 13 3/4 x 4 3/8	Fits (3) per shelf in Standard 48" Wide Unit	Tan	1	25
794-1310	13 1/8 x 10 1/2 x 4 3/8	Fits (4) per shelf in Double Sided Unit	Tan	2	27

### Additional Adjustable Shelving

Model Number	Dimensions*	Description	Weight	Price
700AS246	1 x 22 x 46	Fits in Standard 48" Wide Unit	23	125
700AS230	3/4 x 22 x 30	Fits in Standard Wardrobe Unit	15	81
700AS222	3/4 x 22 x 22	Fits in Standard Divided Shelf Unit	11	60
700AS346	1 x 13 x 46	Fits in Standard 48" Wide Double Sided Unit	14	88
700AS322	3/4 x 13 x 22	Fits in Standard Divided Double Sided Unit	7	43

\*Nominal Dimensions

This page is intentionally blank.

Base Storage Cabinets

411CBS11 - Closed Base Storage

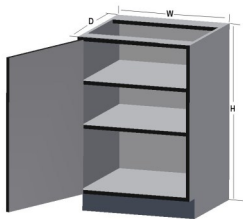

Depth: 16,20,24,30  
Width: 12,15,18,21,24  
Height: 29,35

411CBS12 - Closed Base Storage (Double Doors)

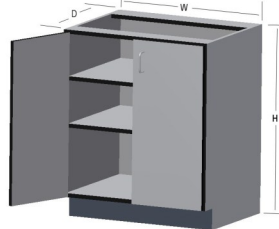

Depth: 16,20,24,30  
Width: 24,27,30,33,36,42,48  
Height: 29,35

411BDD61 - Base Cabinet w/ Drawer

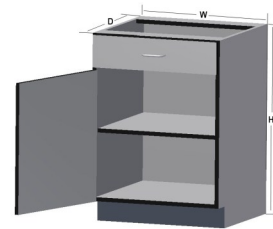

Depth: 16,20,24,30  
Width: 12,15,18,21,24  
Height: 29,35

411BDD62 - Base Cabinet w/ Drawer (Double Doors)

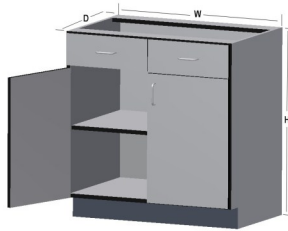

Depth: 16,20,24,30  
Width: 24,27,30,33,36,42,48  
Height: 29,35

411SBS21 - Sink Base Storage

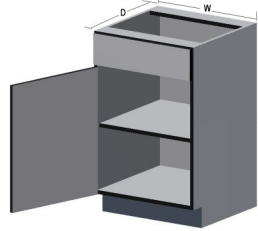

Depth: 16,20,24,30  
Width: 12,15,18,21,24  
Height: 29,35

411SBS22 - Sink Base Storage (Double Doors)

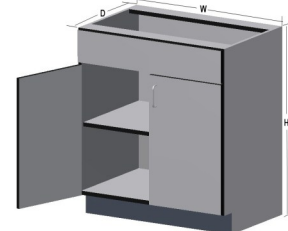

Depth: 16,20,24,30  
Width: 24,27,30,33,36,42,48  
Height: 29,35

411OBS30 - Open Base Storage

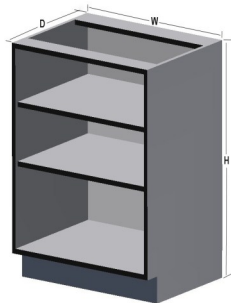

Depth: 16,20,24,30  
Width: 24,27,30,33,36,42,48  
Height: 29,35

411CBC41 - Corner Base Storage

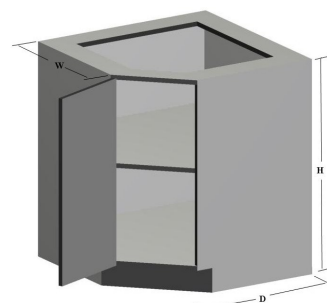

Depth: 16,20,24,30  
Width: 16,20,24,30  
Height: 29,35

Base Storage Cabinets

411BCB51 - Blind Corner Base Storage

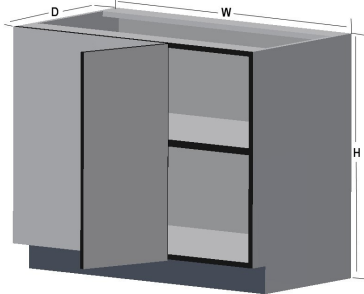

Depth: 16,20,24,30  
Width: 24,27,30,33,36,42,48  
Height: 29,35

411BCB52 - Blind Corner Base Storage (W/ Drawer)

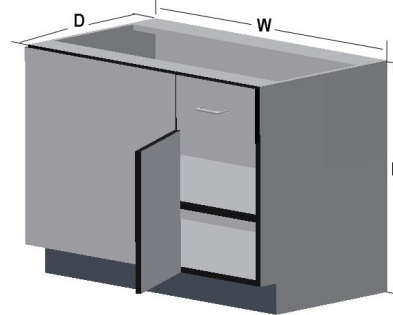

Depth: 16,20,24,30  
Width: 24,27,30,33,36,42,48  
Height: 29,35

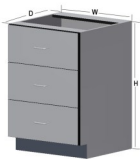

411DBS71  
Drawer Bank  
Box/Box/Box



411DBS72  
Drawer Bank  
Box/Box/Box/Box



411DBS73  
Drawer Bank  
Box/Box/File



411DBS74  
Drawer Bank  
Box/File/File



411DBS75  
Drawer Bank  
File/File

Depth: 24  
Width: 18,24, 30, 36  
Height: 29,35

Tall Storage Cabinets

412CTS11 - Closed Tall Storage

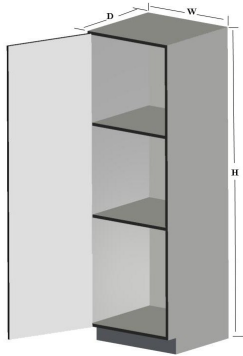

Depth: 16,24  
Width: 12,15,18,21,24  
Height: 48,60,72,84

412CTS12 - Closed Tall Storage (Double Doors)

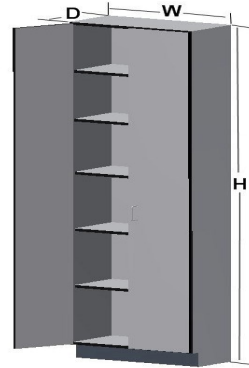

Depth: 16,24  
Width: 24,30,33,36,42,48  
Height: 48,60,72,84

412TWS21 - Tall Wardrobe Storage

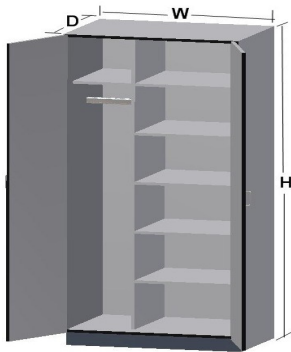

Depth: 24  
Width: 30,36,48  
Height: 48,60,72

412OTS30 - Open Tall Storage

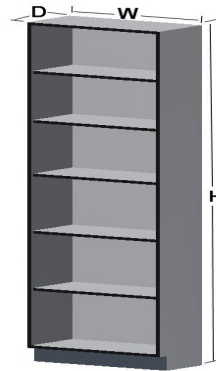

Depth: 16,24  
Width: 24,30,33,36,42,48  
Height: 48,60,72,84



Wall Storage Cabinets

413CWS11 - Closed Wall Storage

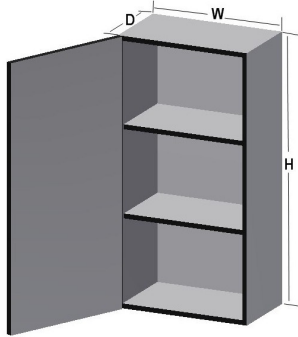

Depth: 12,16  
Width: 12,15,18,21,24  
Height: 24,30,36,48

413CWS12 - Closed Wall Storage (Double Doors)

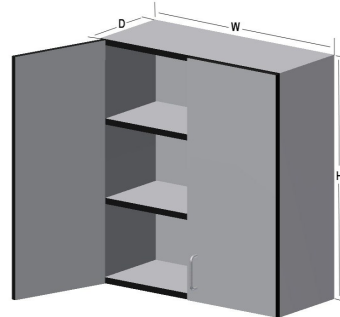

Depth: 12,16  
Width: 24,30,33,36,42,48  
Height: 24,30,36,48

413WCB51 - Blind Corner Wall Cabinet

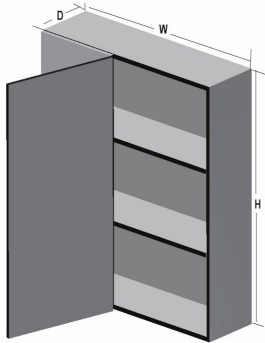

Depth: 12,16  
Width: 24,30,33,36,42,48  
Height: 24,30,36,48

411WCC41 - Corner Wall Storage

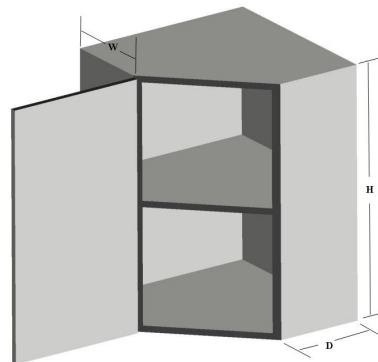

Depth: 12,16  
Width: 12,16  
Height: 20,24,36,48

413OWS30 - Open Wall Storage

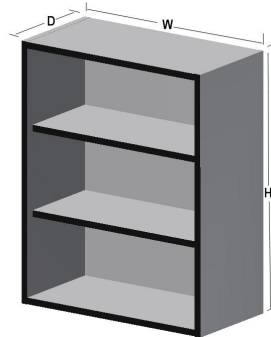

Depth: 12,16  
Width: 24,30,36,48  
Height: 24,30,36,48

## Cabinet Accessories

Custom laminates available. Custom size cabinets available. Call for pricing.

### Adjustable / Fixed Shelving

Model No	Depth	12" W	15" W	18" W	21" W	24" W	30" W	36" W	48" W
419AS/419FS	12" D								
419AS/419FS	16" D								
419AS/419FS	20" D								
419AS/419FS	24" D								
419AS/419FS	30" D								

### Cabinet Divider

Model No	Depth	24" H	30" H	36" H	48" H	60" H	72" H	84" H
419DV	12" D							
419DV	16" D							
419DV	20" D							
419DV	24" D							
419DV	30" D							

### Finished Cabinet Ends (Left or Right )

Model No	Depth	24" H	30" H	36" H	48" H	60" H	72" H	84" H
419FR / 419FL	12" D							
419FR / 419FL	16" D							
419FR / 419FL	20" D							
419FR / 419FL	24" D							
419FR / 419FL	30" D							

### Fillers, Panels, Aprons

Model No	Description	24"	29"	30"	35"	48"	84"
419FL3	3" Filler						
419FL6	6" Filler						
419IC3	3" Inside Corner Filler						
419IC6	6" Inside Corner Filler						
419AP5	5" Apron						
419BP24	24" Back Panel						
419BP36	36" Back Panel						
419BP42	42" Back Panel						

### Locking, Finish, & Edgebanding Options

Door / Drawer Locks	Contact for Pricing
Black or Matching Toekicks	Contact for Pricing
Matching Interiors	Contact for Pricing
Optional Edgebanding	Contact for Pricing

Ordering Information

If you have any questions regarding our products or ordering our products, please feel free to contact us.

Otherwise, our products may be ordered using the appropriate model number and selecting the required options listed along with the item.

Example: (20) 3000 Series Computer Table with Rear Trough, 30 x 48 x 29 1/2"  
 Standard roll edge top, light gray laminate with light gray 3mm PVC Trim  
 Casters. Accessories include an adjustable CPU holder and an Ergonomic Keyboard Tray.

	Model	Front Edge	Laminate Color	Trim Color	Casters	Qty
001	<u>513-D348</u>	<u>R</u>	<u>LG</u>	<u>3</u>	<u>C</u>	20
002	<u>550-1210</u>					20
003	<u>550-1120</u>					20

**TERMS**

All prices are F.O.B. our factory. Net 30 days. Prices and Specifications are subject to change without notice.

**STANDARD COLORS**

Standard laminate colors are natural oak, medium oak, walnut, grand cherry, maple, light gray, gray nebula, beige granite, and ebony sand. Standard PVC and 3mm PVC is black. Standard hardwood corner moldings are natural oak or walnut color. Standard metal finish is black powder coat. Over 200 colors and patterns are available through our extended color options at a minimal up charge, when less than 12 per item. All other colors, request quotation from

**ASSEMBLY FEATURES**

All Computer Lab Furniture, Study Carrels, and Flexible Workstations are shipped RTA unless otherwise noted. Fully assembled units available; request quotation. Moveable Storage Units, Bookcases, Metal Base Tables, Music Cabinets and all other Cabinets are shipped fully assembled. Wood Base Tables require leg assembly.

**SHIPPING**

All merchandise will be shipped as specified by the customer. If no instructions are given, we will select the most reliable and economical method of shipment.

Safe delivery of merchandise is the responsibility of the carrier. If you receive the shipment short or damaged, it is your responsibility to file a claim with the carrier.

*Shipping weights and cube volume shown are approximate and may vary due to changes in product or method of packaging.*

Freight Classification: Fully assembled furniture/cabinets - 125  
RTA furniture/cabinets - 85  
Wood components - 70

**RETURNS**

Returned merchandise will not be accepted without written authorization from Corilam Customer Service Department.

**CANCELLATIONS**

Order changes or cancellations on standard line items are subject to a surcharge once production of order begins. Orders with special laminate colors or sizes cannot be cancelled at any time.

**REPAIR CHARGES**

Authorization must be obtained from Corilam Customer Service Department prior to incurring repair charges.